

# DENON

Hi-Fi Component

## SERVICE MANUAL

# MODEL DCD-1650AR

# MODEL DCD-2880AR

## STEREO CD PLAYER

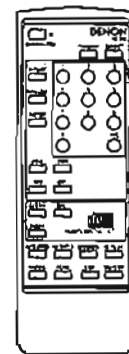
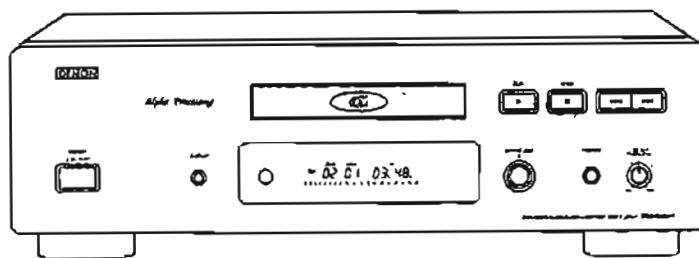

### — TABLE OF CONTENTS —







OPERATING INSTRUCTIONS .....	2-8
DISASSEMBLY .....	9,10
NOTE FOR HANDLING OF THE LASER PICK-UP .....	11,12
CONFIRMING THE SERVO .....	13-16
IC TERMINAL FUNCTION LIST .....	17-21
SEMICONDUCTORS .....	22-23
PRINTED WIRING BOARD .....	24,25
NOTE FOR PARTS LIST .....	26
PARTS LIST OF PRINTED WIRING BOARD .....	26-29
EXPLODED VIEW OF CHASSIS AND CABINET .....	30
PARTS LIST OF EXPLODED VIEW .....	31,32
EXPLODED VIEW OF CD MECHANISM UNIT .....	33
PARTS LIST OF CD MECHANISM UNIT .....	33
WIRING DIAGRAM .....	34
SCHEMATIC DIAGRAM .....	35

• Some illustrations using in this service manual are slightly different from the actual set.

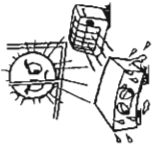
# NIPPON COLUMBIA CO., LTD.

# OPERATING INSTRUCTIONS

## NOTE ON USE

 <ul style="list-style-type: none"> <li>Avoid high temperatures. Allow for sufficient heat dispersion when installed on a rack.</li> </ul>	 <ul style="list-style-type: none"> <li>Keep the set free from moisture, water, and dust.</li> </ul>	 <ul style="list-style-type: none"> <li>Do not let foreign objects in the set.</li> <li>Do not let insecticides, benzene, and thinner come in contact with the set.</li> </ul>
 <ul style="list-style-type: none"> <li>Handle the power cord carefully. Hold the plug when unplugging the cord.</li> </ul>	 <ul style="list-style-type: none"> <li>Unplug the power cord when not using the set for long periods of time.</li> <li>Do not obstruct the ventilation holes.</li> </ul>	 <ul style="list-style-type: none"> <li>Never disassemble or modify the set in any way.</li> </ul>

Thank you for purchasing this DENON Compact Disc Player. Please read the operating instructions thoroughly in order to acquaint yourself with the CD player and achieve maximum satisfaction from it.

## — TABLE OF CONTENTS —

FEATURES	5
NAMES AND FUNCTIONS OF PARTS	6, 7
CONNECTION	8
OPENING AND CLOSING THE DISC HOLDER AND LOADING A DISC	8
NORMAL CD PLAYBACK	9
ADVANCED CD PLAYBACK	9 - 13
PLAYBACK USING THE REMOTE CONTROL UNIT	14, 15
THE COMPACT DISC	15
TIMER-CONTROLLED PLAYBACK	16
INSTALLATION PRECAUTIONS	16
TROUBLESHOOTING	16
SPECIFICATIONS	16

Please check to make sure the following items are included with the main unit in the carton:

- (1) Operating instructions
- (2) Remote Station Unit
- (3) Connection Cord
- (4) Remote Control Unit RC-255
- (5) R67/AA Dry Cell Battery
- (6) AC cord

NOTE: This CD player uses the semiconductor laser. To allow you to enjoy music at a stable operation, it is recommended to use that in a room of 5°C (41°F) — 35°C (95°F).

CAUTION: USE OF CONTROLS OR ADJUSTMENTS OR PERFORMANCE OF PROCEDURES OTHER THAN THOSE SPECIFIED HEREIN MAY RESULT IN HAZARDOUS RADIATION EXPOSURE.

THE COMPACT DISC PLAYER SHOULD NOT BE ADJUSTED OR REPAIRED BY ANYONE EXCEPT PROPERLY QUALIFIED SERVICE PERSONNEL.



ISERSTÄLLING VED ÅBNING, MÅR SAFBRYDERE ER UDE AF FUNKTION. SÆTTELSE FOR STRÅLING. ÅYTTÄMINEN MUULLA KUIN TÄSSÄ JESSÄ KÄYTTÄMÄLLÄ TAVALLA SAATTAA ÄYTTÄJÄN TURVALLISUUSLUOKAN 1 E NÄKYMÄTTÖMÄLLÄ LASERISÄTELYLLE. ITEN ANVÄNDS PÅ ANNAT SÄTT ÄR DENNA ISNING SPECIFIKERATS. KÄN ANVÄNDAREN FÖR ÖNSYNLIG LASERSTRÅLNING SOM ER GRÄNSEN FÖR LASERKLASS 1.

DECLARATION OF CONFORMITY  
We declare under our sole responsibility that this product, to which this declaration relates, is in conformity with the following standards:  
EN60068-2-13, EN55022, EN60955-2 and EN60955-3.  
Following the provisions of 73/23/EEC, 89/338/EEC and 93/68/EEC Directive.



is the  mark  
t-shaped CDs, octagonal CDs etc. cannot  
app the set. Do not use such CDs.

ick, do not open the top cover  
R DENON DEALER  
spill liquid inside the CD player  
ngly/issult.

ETTY  
OCK HAZARD, DO NOT EXPOSE THIS  
MOISTURE.

TO REDUCE THE RISK OF FIRE OR ELECTRIC SHOCK, DO NOT EXPOSE THIS APPLIANCE TO RAIN OR MOISTURE.

CAUTION: TO REDUCE THE RISK OF ELECTRIC SHOCK, DO NOT REMOVE COVER (OR BACK). NO USER-SERVICEABLE PARTS INSIDE. REFER SERVICING TO QUALIFIED SERVICE PERSONNEL.



A flash with arrowhead symbol, within an equilateral triangle, is intended to alert the user to the presence of "dangerous voltage" within the product's enclosure that may be of sufficient magnitude to present a risk of electric shock to persons.

## NAMES AND FUNCTIONS OF PARTS

### FRONT PANEL

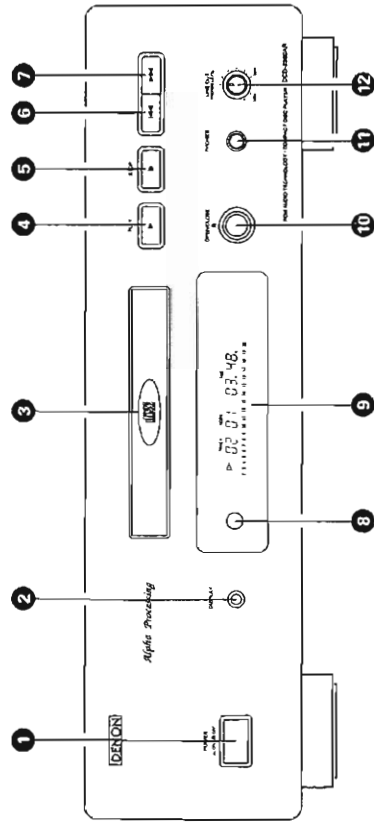

### REAR PANEL

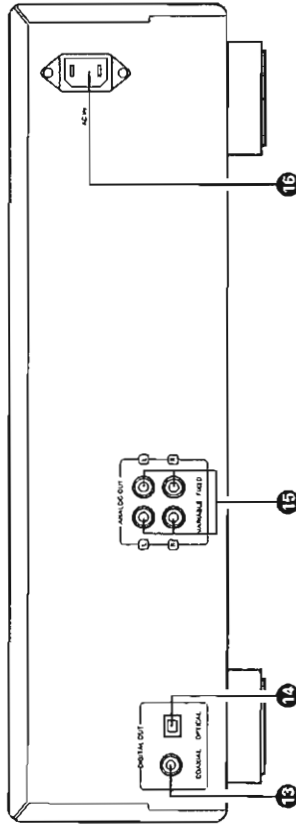

### 1 Power Switch (POWER)

- When the power is turned on, "CC" appears on the TIME display, and if no disc is loaded, "00:00:00" appears on the digital display.
- If the power is turned on with a disc already loaded, the total number of tracks on the disc is displayed on the TRACK/NO display, the total time is displayed on the TIME display, the numbers on the music color indicator light up to the number of tracks on the disc, and playback begins.

### 2 Display Button (DISPLAY)

- Press this button to change the brightness of the display.
- Press once to make the display 2/3 as bright as normal.
- Press again to make the display 1/3 as bright as normal.
- Press once again to turn the entire display off during playback and all but the track number off in any other mode.

### 3 Disc Holder

- Place the disc on the disc holder with the label facing up.
- Use the open/close button (⏏ OPEN/CLOSE) to open and close the disc holder.
- The disc holder may also be closed by pressing the play button (▶ PLAY).

### 4 Play Button (▶ PLAY)

- Press this button to start playback of a disc.
- When this button is pressed, ⏏ is displayed, and the track number being played is displayed together with the elapsed playback time of the track.
- Tracks are shown on the calendar display. Once a track has been played, the corresponding track number goes out on the calendar display.

### 5 Stop Button (■ STOP)

- Press this button to stop playback.
- The disc will stop rotating, and the number of tracks and total playing time of the disc are displayed on the TRACK/NO. and TIME displays, respectively.
- In case programmed playback is engaged when this button is pressed, the number of tracks and total playing time of the program are displayed.

### 6 Automatic Search Reverse Button (◀◀◀)

- Press this button to return the pickup to the beginning of the present track. Press again to return to other tracks.
- By pressing the button a number of times, the pickup will move back the corresponding number of tracks.

### 7 Automatic Search Forward Button (▶▶▶)

- Press this button to move the pickup forward to the beginning of the next track. Press again to move ahead to other tracks.
- By pressing the button a number of times, the pickup will advance the corresponding number of tracks.

### 8 Remote Control Sensor

- This sensor receives the infrared light transmitted from the wireless remote control unit.
- For remote control, point the supplied remote control unit RC-265 towards this sensor.
- When a signal is transmitted from the remote control unit, the remote control indicator in the display (▶) will light up briefly.

### 9 Display

- The digital display is divided into sections, such as displays for track number, index, playback time and calendar, as shown below.

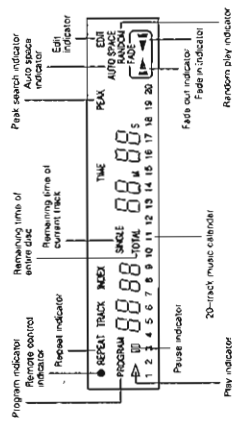

### 10 Open/Close Button (⏏ OPEN/CLOSE)

- The disc holder is opened and closed by pressing this button.
- Press this button once to open the disc holder, and once again to close it.
- When the disc holder is closed with a disc loaded, the disc will rotate for a couple of seconds while the disc contents are read. The number of tracks and total playback time on the disc are then displayed on the digital display.

### 11 Headphones Jack (PHONES)

- For private listening, you can connect your headphones to this jack. Do not raise the volume level too much when listening through headphones. (Headphones are sold separately.)

### 12 Volume Control (LINE OUT/PHONES LEVEL)

- Use this to adjust the output level (VOLUME) of the headphones or the line out (VARIABLE) output level.

### 13 Digital Output Jack (COAXIAL)

- This jack outputs digital data.
- We recommend using a 75 Ω (ohm) pin cord (available in stores) for connections.

### 14 Digital Output Jack (OPTICAL)

- Digital data is output in optical form from this jack.

### 15 Output Terminal (VARIABLE FIXED)

- Connect these jacks to the main jacks on your amplifier. (Refer to page 8 for details on the connections.)

### 16 AC IN Connector (AC IN)

- Connector for the included AC power cord here.
- Do not use any other cord than the provided AC power cord.

### Continuous Button Operation

If the automatic search reverse button (◀◀◀), the automatic search forward button (▶▶▶) are held on, the function of that button will be repeated.

### OPENING AND CLOSING THE DISC HOLDER AND LOADING A DISC

**Opening and closing the disc holder:** (This operation only works while the power is on.)

1. Press the power switch (POWER) to turn on the power.
2. Press the open/close button (OPEN/CLOSE).

#### How to load a disc

- Make sure the disc holder is completely open.
- Hold the disc by the edges and place it on the disc tray. (Do not touch the signal surface, i.e., the glassy side.)
- When using 12 cm diameter discs, make sure the outer edge matches the tray guide circumference (Fig. 1), and when using CD singles (8 cm diameter) match the outer edge with the inner tray guide circumference. (Fig. 2)
- Press the open/close button (OPEN/CLOSE) to close the disc holder.
- When the disc holder is closed, the disc is read and after a few seconds the number of tracks and total playing time are displayed on the TRACK/NO and TIME displays, respectively.
- When the disc holder is open and a disc is loaded, you may also press the play button (PLAY) to close the disc holder. If the play button (PLAY) is pressed, playback will start immediately upon the disc contents having been read.

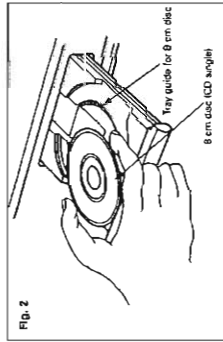
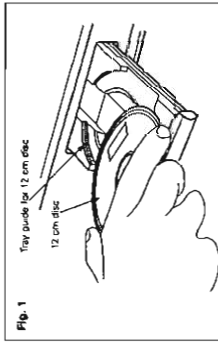

#### Caution:

- If your finger should get caught in the disc holder when it closes, press the open/close button (OPEN/CLOSE).
- Do not place any foreign objects on the disc tray, and do not place more than one disc on the tray at a time. Otherwise malfunction may occur.
- Do not push in the disc tray deeply when the power is off as this may cause pulling out of the disc tray.
- A buzz may be heard from the main unit when discs are inserted. This sound is produced when the internal servo circuit is being automatically adjusted for the disc.
- A click may be heard from the main unit when the disc holder is closed. This is the sound of the disc detection mechanism.

minial (FIXED-VARIABLE) connect the left (L) and right (R) output terminals of the DCD-1650AR/2880AR to the CD, AUX, or (R) input jacks of the amplifier.

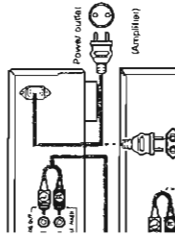

... put Jack (COAXIAL) connect the digital output jack (COAXIAL) of the digital input jack (COAXIAL) on a digital receiver to a CD.

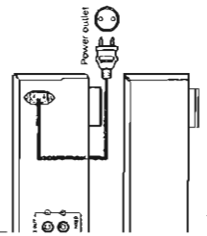

Optical Output Jack (OPTICAL) connect the digital optical output jack on the DCD to the optical input jack on a digital processor or MD.

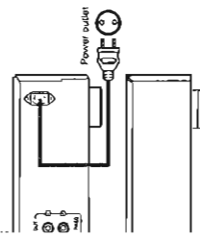

connections of cables and power components off. Connect properly to the L (left) and R (right) jacks on an amplifier CD, AUX or TAPE PLAY output jacks.

### NORMAL CD PLAYBACK

#### (1) Starting Playback

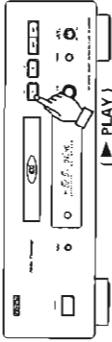

1. Turn the power switch on and load the disc.
  2. Press the play button (PLAY).
- The number of the track currently playing, the index number, and the elapsed time, etc., are displayed.

#### (2) Stopping Playback

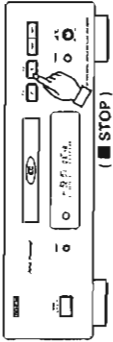

1. Press the stop button (STOP).
- The stop mode is set automatically once all tracks on the disc are played.
- NOTES:**
- If no disc is loaded or if the disc is loaded upside-down, the track number, index, and time displays will all read zero, and the entire calendar will light.

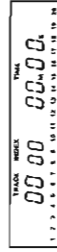

- If the information at the innermost edge of the disc cannot be read properly due to dirt or scratches, the display will be as shown below, and the number of tracks and remaining time per track will not be displayed. Also, the search operation may take longer than usual.

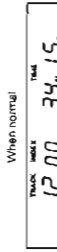

When normal

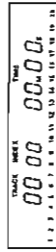

### ADVANCED CD PLAYBACK

1. Playing a Specific Track (Remote control only)

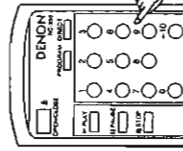

1. Use the number buttons and the +10 button to input the number of the desired track. For example, to play the fourth track press [+], and to play the 12th track press [+10] and [2]. The beginning of the track is found and playback starts.

### 2 Moving to Following Tracks During Playback

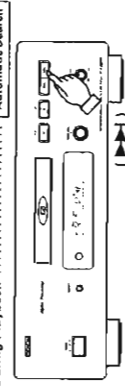

Press the automatic search forward button (▶▶).

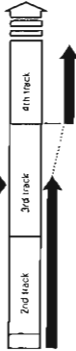

1. Press the automatic search forward button (▶▶). If the automatic search forward button (▶▶) is pressed again during the search operation, the pickup moves on to the next track, etc.

### 3 Returning to the Beginning of the Current Track

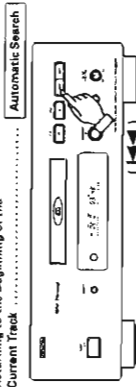

Press the automatic search reverse button (◀◀).



1. Press the automatic search reverse button (◀◀). If the automatic search reverse button (◀◀) is pressed again during the search operation, the pickup moves on to the previous track, etc.

### 4 Finding Sections Within a Track (Remote control only)

- Use the function to start playback from certain sections within a track divided by index numbers.

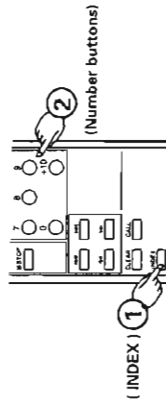

1. Press the INDEX button "INDEX" appears at the TRACK NO display.

- 2 Use the number buttons and the +10 button to specify the track number. The track number now appears at the INDEX display. Input the desired index number. Playback starts from there. For example, to start listening from index number 2 on track 3, press INDEX, 3 and 2.

**Indices**

- Indices are numbers which are assigned to sections within a track.
- Check the disc's explanatory notes for the index numbers.
- If you make an index search for an index number that is not on the disc, playback will start from the last index number on the track.

- 5 **Playing Specific Tracks in a Specific Order** (Remote control only)
  - With this function, you can choose any of the tracks on the disc and program them to play in any order.
  - Programming is possible with the disc holder open.
  - Up to 20 tracks can be programmed.
  - The programmed tracks are shown on the calendar.

11) **Programming** (Remote control only)

(PROGRAM) 1 (Number buttons) 2

- The PROGRAM indicator lights when the program button (PROGRAM) is pressed. Next, use the number buttons and the +10 button to program the tracks. To program tracks 3, 12, and 7, for example, press PROGRAM, 3, 12, 7, and 7.
- The track number lights on the calendar each time a track is programmed. The number of tracks programmed is displayed at the index display, and the total playing time for the programmed tracks is indicated at the time display. After the tracks are programmed, the total number of programmed tracks is displayed at the track number display, and the total playing time for the programmed tracks is indicated at the time display.

12) **Checking the Programmed Tracks** (Remote control only)

(CALL)

- Press the CALL button. The programmed tracks are displayed in order on the TRACK NO. display each time the CALL button is pressed.

13) **Playing the Programmed Tracks**

(PLAY)

- Press the PLAY button to play the tracks in the programmed order.

- 14) **Correcting Programs** (Remote control only)

(CLEAR) (Number buttons)

- To correct a programmed track, first press the CLEAR button, then program the correct track.
- The last track programmed is replaced with the correct track.
- To clear a track in the middle of the program, use the CALL button to call out that track, then press the CLEAR button to clear it from the program.
- 15) **Clearing the Entire Program** (Remote control only)
  - Press the DIRECT button to clear the entire program.
  - If the DIRECT button is pressed during programmed playback, the program mode is cleared and normal playback continues from that track on.

(DIRECT)

NOTES:

- If the programming operation is performed in the play or pause mode, the current track is programmed as the first track in the program. Other programs can be added, but the number of programmed tracks and playing time will not be displayed.
- Direct search is not possible during programmed playback. Pressing the number buttons adds tracks to the end of the program.
- Programming is also possible when the disc holder is open. A track number greater than the number of tracks on the disc can be set in the program, but it will automatically be cleared from the programmed playback starts.
- The remaining time per track can only be displayed for the first 20 tracks on the disc.
- The total program time and remaining program time as well will not be displayed if tracks number greater than 20 are programmed.

- 6 **Playing All Tracks Repeatedly** (Remote control only)

(PLAY) 2 (Repeat Playback)

- Press the REPEAT button. The REPEAT indicator lights.
- The operation is the same whether button 1 or 2 is pressed first.
- The one-track repeat mode is set if the REPEAT button is pressed again during repeat playback.

- The all-track repeat mode is set even if the REPEAT button is pressed during playback.
- To cancel the repeat mode, press the REPEAT button twice.
- If the REPEAT button is pressed during programmed playback, the tracks are repeated in the programmed order.

7 **Playing a Single Track Repeatedly** (Remote control only)

(REPEAT)

Press the REPEAT button twice.

- Press this button when you hear a track you want to play repeatedly.
- Press the REPEAT button twice during playback. The REPEAT indicator lights, and if you are in track number 20 or less, the number appears on the calendar display and the track is played repeatedly.
- For tracks 21 and above, the track number is not displayed on the calendar display, but the track number will flash on the stop button.
- If the REPEAT button is pressed twice in the stop mode, 1 appears on the calendar display and one-track repeat is possible. Press the PLAY button to start playback.
- Press the REPEAT button once again to cancel the one-track repeat mode.
- The display and playback return to normal.

- 8 **Stopping Momentarily During Playback** (Remote control only)
- Playback can be stopped momentarily then resumed from the same point.

11) PAUSE (Pause)

- 11) PAUSE (Pause)

Press the pause button (II PAUSE)

- 7 Press the play button (I PLAY) or the pause button (II PAUSE). To resume playback, press either the play button (I PLAY) or the pause button (II PAUSE).

- 8 **Finding a Track While Listening at High Speed** (Manual Search)
  - You can skip through the disc while listening at high speed.
  - This function comes in handy for finding a certain part in the middle of a long track and starting playback from there.

- Once you find the desired position using the manual search operation, release the manual search forward button (▶▶▶) or manual search reverse button (◀◀◀) to start normal playback.

- 11) **Manual Search Forward** (Remote control only)

(▶▶▶)

Hold in the manual search forward button (▶▶▶)

- During playback, press and hold in the manual search forward button (▶▶▶) to skip through the disc while listening at high speed.
- The number of the track being skipped through, the index number, and the elapsed time for that track are indicated on the display window.
- In the pause mode, the disc moves at about three times the speed as during the play mode, but no sound is heard.
- When the end of the last track is reached while pressing the manual search forward button (▶▶▶), "JJ" appears on the display window and the manual search operation is stopped.
- To resume playback, press the manual search reverse button (◀◀◀), then do another operation once the "JJ" disappears from the display.

- 12) **Manual Search Reverse** (Remote control only)

(◀◀◀)

Hold in the manual search reverse button (◀◀◀)

- During playback, press and hold in the manual search reverse button (◀◀◀) to skip through the disc while listening at high speed.
- The display is the same as during the manual search forward operation.
- In the pause mode, the disc moves at about three times the speed as during the play mode, but no sound is heard.
- When the beginning of the first track is reached while pressing the manual search reverse button (◀◀◀), "LL" appears on the display window and the manual search operation is stopped.
- To resume playback, press the manual search forward button (▶▶▶), then do another operation once the "LL" disappears from the display.

**Tracks** (Remote control only)

Auto Space (Remote control only)

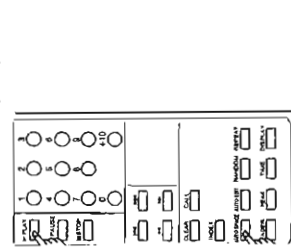

case between tracks, making editing easier.

When the auto space button is pressed, the track will start playback. When the end of a track is reached, approximately 4 seconds is reserved before the player will turn the auto space function off.

**Order** (Remote control only)

Random Playback (Remote control only)

The disc can be played once in random order.

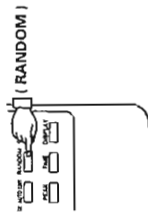

When the RANDOM button is pressed, the RANDOM indicator will flash. The disc will be played in random order. When the repeat function is selected, the disc will be played in random order, after which all tracks will be played in random order, and so on.

When the random function is selected, the track numbers from the first to the last track will be displayed on the track number display, so that the player will know the order in which the tracks will be played next until playback begins.

When the random button (RANDOM) is pressed during the random mode, the track numbers will be displayed on the track number display, so that the player will know the order in which the tracks will be played next until playback begins.

**Auto Edit** (Remote control only)

The auto edit function automatically divides the tracks on the compact disc into sides A and B, with the division at the beginning of a track in such a way that the disc's total playing time is divided as close as possible by one half.

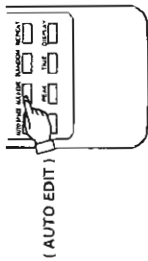

When the AUTO EDIT button is pressed in the stop condition, the total play time of side A (the first half) and the track numbers (on the calendar) are displayed for about 2 seconds. Next, the side B (the second half) information is displayed after which the player automatically pauses at the beginning of the first track of side A. EDIT and PROGRAM will be lit on the display at this time.

Pressing the play button (▶) or the pause button (⏸) will start the play mode. When side A has finished playing, the player will pause at the beginning of the first track on side B.

Pressing the play button (▶) or the pause button (⏸) will start the play mode again. When side B has finished playing, the player automatically stop.

**NOTES:**

- The auto edit function will not work for discs containing 21 tracks or more.
- Pressing any buttons other than the play (▶) or pause (⏸) buttons during auto editing will cause auto editing to operate improperly.

**Fading Out or Fading In at the Desired Location** (Analog output only)

Fading out and fading in is possible at the desired position during play.

Fade Out (Remote control only)

When the fader button (FADER) is pressed during play, fade out will be provided for about 5 seconds. The fader indicator will flash during the operation and (▶) will flash. When fade out is completed the player will automatically pause.

**Fade In**

When the fader button (FADER) is pressed from the pause mode, the player will start playing and fade in will be provided for about 3 seconds. (▶) will flash up during the operation and (▶) will flash.

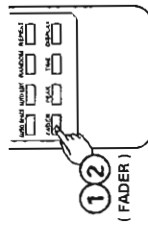

**Setting the Fade Out Time in Advance (TIME FADE)** (Remote control only)

When the fader button (FADER) is pressed in the stop mode, the FADE indicator (▶) will light up. TIME will appear as --:--:-- and the player will wait for the input of the fade out time.

Input the fade out time with the 10-91 number buttons.

Pressing the play button (▶) or the pause button (⏸) will start the playback and the FADE indicator (▶) will light up.

The (▶) indicator will start flashing 5 seconds before the specified fade out time and then the fade out will begin. The fade out will end at the specified time and the player will automatically pause.

The time fade function will be cancelled if an auto search or manual search is performed during playback.

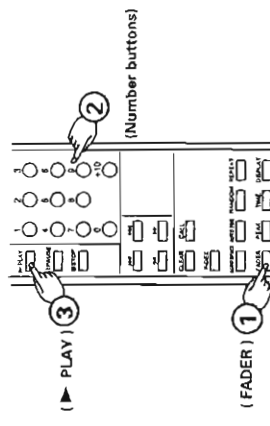

**To Search for the Peak Level of the Disc** (Remote control only)

The player searches for the peak portion and plays a few seconds either side of this point repeatedly. This is convenient for making recording adjustments on the tape recorder.

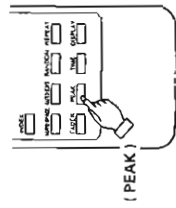

When the peak search button (PEAK) is pressed in the stop mode, the PEAK indicator will flash and the player will search for the portion having the peak level.

After the search, the PEAK indicator lights up and a few seconds either side of the peak level point are played back repeatedly. This is convenient for making recording adjustments on the tape recorder.

To cancel the peak search, press the stop (■) button.

During the peak search, pressing the play (▶) or the pause button (⏸) will go to the beginning of the first track (the first track of the program for program playback, or the track that was first selected in the time edit) and begin playback from there if the play button was pressed or enter the pause mode if the pause button was pressed.

**NOTES:**

- The peak search function reads the level of the disc from the beginning of the disc to the end at a fixed interval and regards the maximum value that was read as the peak. Peak search takes a little time for this reason.
- The peak portion may change each time the disc is read and there may be slight difference in the actual peak level, but since this difference is so slight there will be no adverse effects on the adjustment of the recording level.
- The time fade function is cancelled when the peak search operation is performed. To use the time fade function, set to the stop mode when reading the disc.
- Buttons for the search, open/close button (▶), OPEN/CLOSE, play button (▶), PLAY, pause button (⏸), PAUSE, and stop button (■) will not function during peak search or repeat play of the peak portion.

**PLAYBACK USING THE REMOTE CONTROL UNIT**

The accessory RC-255 remote control unit can be used to control the CD player from a convenient distance.

- (1) **Inserting the dry cell batteries**
1. Remove the battery cover on the back of the remote control unit.

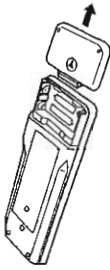

2. Insert two R6P (standard size AA) dry cell batteries with correct polarity as indicated inside the battery compartment.

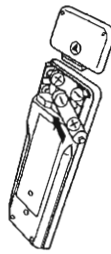

3. Replace the battery cover.

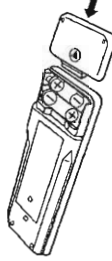

**Notes on the Batteries**

- The remote control unit uses standard size AA dry cell batteries.
  - The batteries will need to be replaced approximately once a year. Replacement may be necessary earlier, depending on how much the remote control unit is used.
  - If, in less than a year, from the time new batteries were inserted, the remote control fails to operate the CD player from a near-by position, it is time to replace the batteries.
  - Insert the batteries properly, following the polarity diagram inside the battery compartment. In other words make sure (+) and (-) terminals are properly aligned.
  - Batteries are prone to damage and leakage.
- Therefore:
- Do not combine new batteries with used ones.
  - Do not combine different types of batteries.
  - Do not join up opposite poles of the batteries, expose them to heat, break them open nor expose of them in open fire.
  - If the remote control unit is not to be used for a long period of time, remove the batteries from the unit.
  - If the batteries have leaked, remove any trace of battery fluid from the battery compartment, wiping thoroughly with a dry cloth. Then insert new batteries.

**121 Directions for Use**

- Operate the remote control unit while pointing it towards the remote control sensor on the CD player (see below).

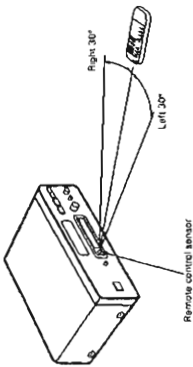

When a remote control signal is received, the remote control indicator on front of the CD player lights briefly.

- The remote control unit can be used at a distance up to 8 meters in a straight line from the CD player. This distance decreases if there are obstructions blocking the signal path or when the remote control unit is operated at an angle from the remote control sensor.
- The buttons on the remote control unit have identical functions with those on the CD player.

However, the following functions cannot be remote controlled: Power ON/OFF

**Caution on Use**

- Do not press the operation buttons on the main unit and on the remote control unit simultaneously, as this will result in malfunction.
- The remote control unit may not operate properly if the remote control sensor is exposed to direct sunlight or strong artificial lighting, or if there is an object between the remote control unit and the remote control sensor.

**REMOTE CONTROL UNIT RC-255**

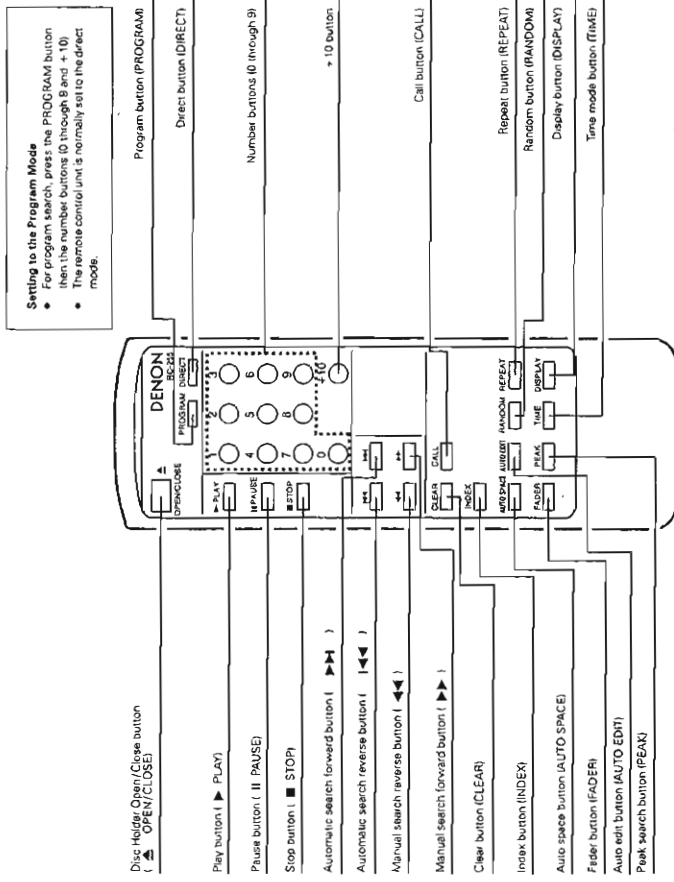

- **Direct Search**  
Normally, direct search is possible simply by pressing the desired number buttons.
- **Program Search (During playback, the track which is currently playing is programmed as the 1st track.)**  
Press the PROGRAM button, then press the number buttons.  
For example, to program tracks number 3, 1, 1, and 5, press PROGRAM → 3 → + 10 and 1 → 5.  
To cancel the program, press the DIRECT button.
- **Clear button**  
This button is used both for clearing when in the program mode and for clearing the index search mode.
- **Inputting the Track Numbers**  
For track numbers below 9, simply press the corresponding button. For track numbers of 10 and greater, press the + 10 then the number buttons. For example, for track number 22 press + 10 twice then 2.

**THE COMPACT DISC**

1. **Precautions on handling compact discs**
  - Do not allow fingerprints, oil or dust on the surface of the compact disc. If the signal surface is dirty, wipe it off with a soft, dry cloth. Wipe in circles from the center and out.
  - Do not use water, benzene, thinner, record spays, electrostatic proof chemicals, or alcohol-wetted cloth to clean discs.
  - Always be care when handling discs to prevent damaging the surface.
  - Do not touch compact discs.
  - Do not apply heat to compact discs.
  - Do not enlarge the hole in the center of the disc.
  - Do not write on the disc and do not attach any labels.
2. **Precautions on storage**
  - After playing a disc, always return it to its case.
  - Keep discs in the cases when they are not to be played. This will protect them from dust and dirt and prolong their service life.
  - Do not store discs in the following places:
    1. Places exposed to direct sunlight for a considerable time
    2. Places subject to accumulation of dust or high humidity
    3. Places exposed to high temperatures, such as close to heater outlets.

**TIMER-CONTROLLED PLAYBACK**

- **Operation**
  1. Turn on the power of all system components.
  2. Set the input selector on the amplifier to correspond to the input the CD player is connected to.
  3. Make sure a disc has been loaded in the disc holder.
  4. Check the time on the timer and then set the desired turn-on time.
  5. Turn the audio timer ON.  
Power is turned off automatically in all components connected to the timer.
  6. When the preset turn-on time is reached, power is turned on in the system components, and CD playback starts from the first track.
- **Connection**

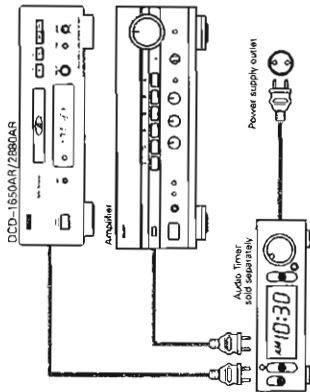

**INSTALLATION PRECAUTIONS**

- The CD player uses a microcomputer for controlling internal electronic circuits. In the event that the player is used while a near-by tuner or TV is turned on, although unlikely, interference could occur either in the sound from the tuner or the picture of the TV. To avoid this, please take the following precautions.
- Keep the CD player as far away from the tuner or TV set as possible.
  - The antenna wires of the tuner and TV should not be connected to the antenna of a particular player. If they do occur, when an indoor antenna or a 300 Ohm resistor cable is used, use of an outdoor antenna and 75 Ohm coaxial cable is strongly recommended.

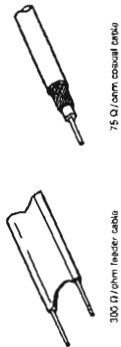

**TROUBLESHOOTING**

- If the CD player does not seem to be functioning properly, check the following:
- Disc holder does not open or close.
    - Is the power ON? See page 8
    - Is the disc loaded properly? See page 8
    - Is the disc loaded properly? See page 8
    - When a disc is loaded, the disc is not played. See page 8
    - When a disc is loaded, the disc is not played. See page 8
    - When a disc is loaded, the disc is not played. See page 8
  - There is no sound or it is distorted.
    - Is the output cord properly connected to the amplifier? See page 8
    - Have the amplifier controls been set correctly? See page 8

- A specific section of the disc will not play.
  - Is the disc dry or scratched? See page 15
  - Have programming been properly done? See pages 10 and 15
- Incorrect operation when buttons on the remote control are pressed.
  - Is the remote control unit being operated properly? See page 14
  - Is the remote control exposed to strong light? See page 14
  - Are the batteries exhausted? See page 14
  - No data is output from the digital output jack (OPTICAL/COAXIAL).
    - Is the jack cord properly connected? See page 8

**SPECIFICATIONS**

<b>AUDIO</b>	<b>Weight:</b> 11.9 lb (5.4 kg)
No. of Channels:	2 channels
Frequency Response:	20 - 20,000 Hz
Dynamic Range:	118 dB
Signal-to-noise Ratio:	0.0019% (1 kHz)
Harmonic Distortion:	Below measurable limit.
Wow & Flutter:	±0.001% W/pulse
Output (Analog):	2.0 V, VARIABLE 0-2.0 V
Output (Digital):	COAXIAL: 10.5 Vp-p 75 Ohm
<b>DISCS</b>	OPTICAL
<b>GENERAL CHARACTERISTICS</b>	Compact Disc format
Power Supply:	DCD-1650AR AC 120 V, 60 Hz (Between F.O.C. models)
	DCD-2880AR AC 230 V, 50 Hz (AA6 model)
	25 W
Power Consumption:	434 (100) x 135 (41) x 340 (105) mm
Dimensions:	(17-3/32" x 5-1/8" x 13-29/64")

- Direct selection, automatic search, programmed playback, repeat playback, manual search, auto stop, time mode, auto stop, peak search, fade
- Headphones jack
- Headphones jack
- RC-255
- Infrared pulse system
- 3 V DC, two RGP (standard sup AA) dry cell batteries (18 (D) min. CR2016A, 6-31, 32, 445/64, 7)
- 100 g (3.5 oz) including batteries

\* Design and specifications are subject to change without notice in the course of product improvement.



## DISASSEMBLY

(To reassemble reverse disassembly)

### 1. Top Cover

1. Remove 2 screws from rear side and 4 screws from both sides, then remove 5 upper screws.
2. Detach the Top Cover as shown in the arrow direction.

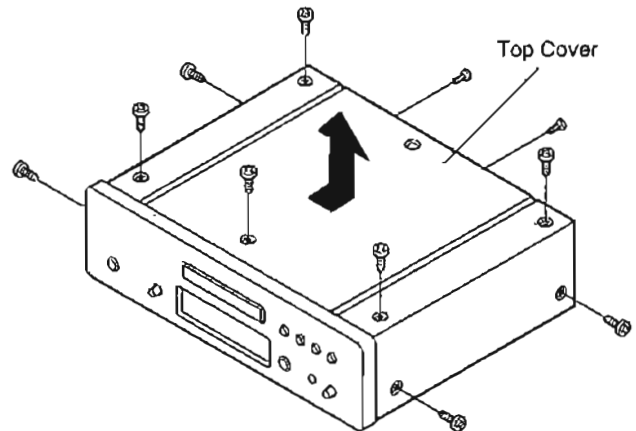

### 2. Front Panel

1. Remove 3 upper screws and 2 below screws.
2. Detach the Front Panel as shown in the figure.

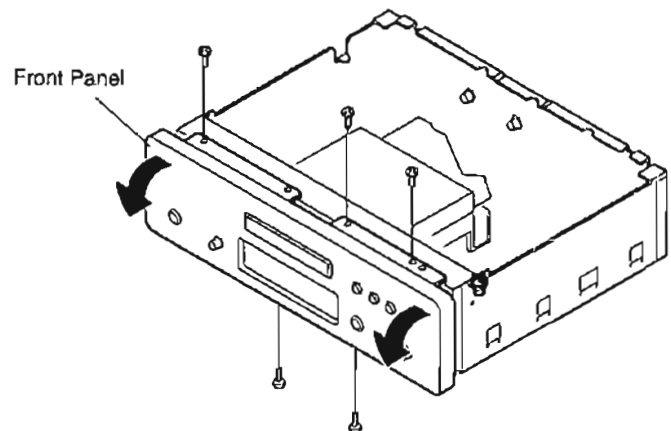

### 3. Bottom Cover

1. Remove 12 screws from bottom side.
2. Detach the Bottom Cover as shown in the arrow direction.

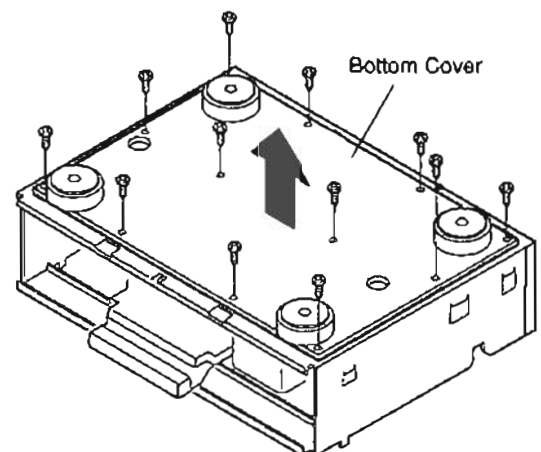

#### 4. Mechanism Unit

1. Remove 3 screws fixing the Front Panel and 2 screws fixing the Front Angle, then detach the Front Panel and Front Angle together as shown in the figure.
2. Remove 6 screws fixing the Mechanism Cover and detach the Mechanism Cover as shown in the arrow direction.
3. Remove 4 screws fixing the Mechanism Unit, then detach the Mechanism Unit as shown in the figure.

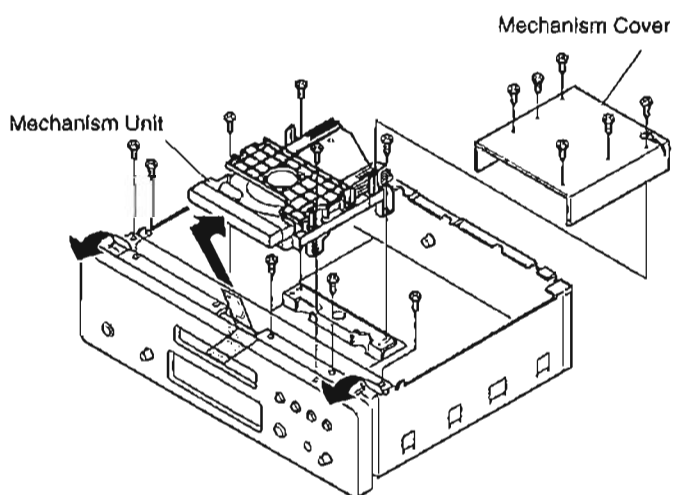

#### 5. Clamper

1. Remove 4 screws fixing the Clamper.
2. Detach the Clamper as shown in the direction.

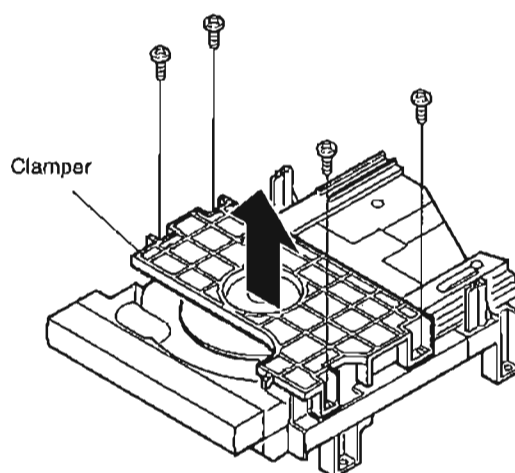

# NOTE FOR HANDLING OF LASER PICK-UP

## Description of the Components

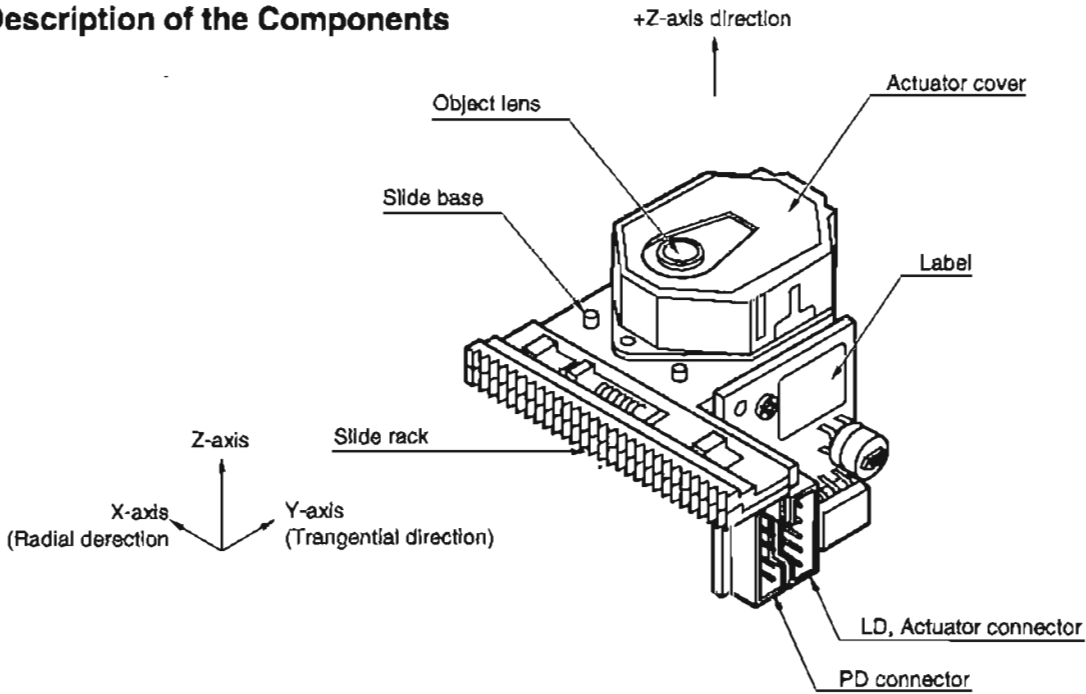

## Wiring Diagram

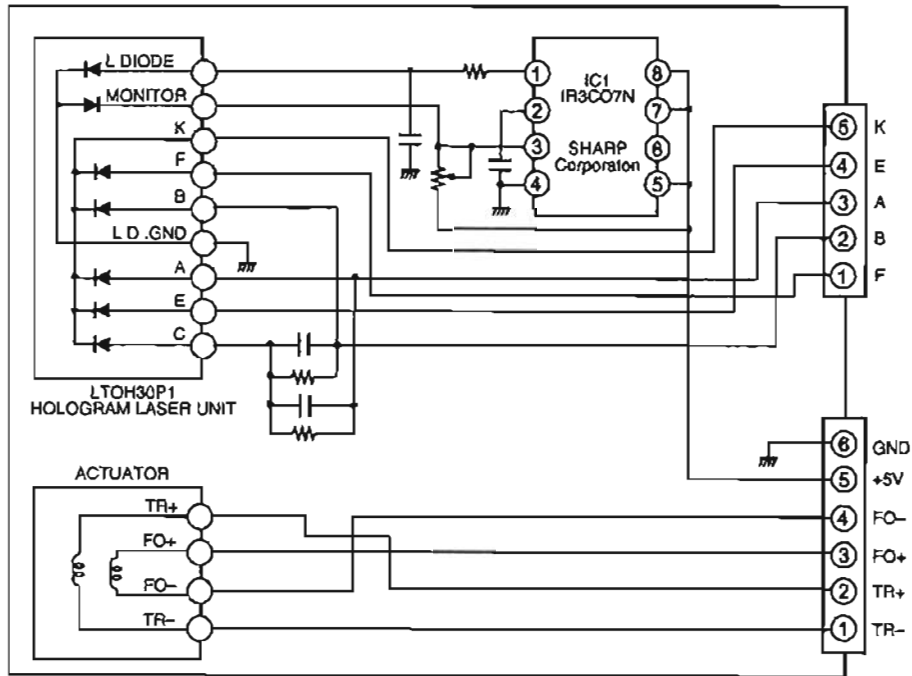

## Connector Order

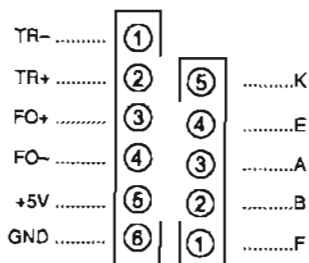

## Connector Mode

Maker: NIHON ACCHAKUTANSHI (Corp.)  
 Mode: Pick-up side B5B-PH-K B6B-PH-K  
 Other side BHR-5 PHR-6  
 Contact SPH-002T-P0.5S

## Caution for Handling the Laser Pick-up

The laser pick-up HPC-IC is assembled and precisely adjusted using a sophisticated manufacturing process in our plant. Do not disassemble or attempt to readjust it. Please keep the following instructions carefully in handling pick-up.

### 1. Handle with Care

#### (1) Storage

Do not store the pick-up in dusty, high-temperature or high-humidity environments.

Please make pick-up faces objective lens upward (pick-up toward +Z axis direction) when storage and transport.

#### (2) Handling

Please take care for preventing from shock by falling down or careless handling.

### 2. Laser Diode (LD)

#### (1) Protect your eyes

The laser beam may damage the human eye, since the intensity of the focused spot may reach  $7 \times 10^3$  W/cm<sup>2</sup> even if the intensity at the objective lens is 400μW maximum. As the light beam spreads after focused through the objective lens, it does not effect you in the place as far as more than 30 cms. However, do not look at the laser light beam either through the objective lens directly nor another lens or a mirror.

#### (2) Poison of As

Since the LD chip contains As (Arsenic), as GaAs + GaAlAs, as known as the poison, although the poison is relatively weak, in comparing with others, e.g. As<sub>2</sub>O<sub>3</sub>, AsCl<sub>3</sub> etc., and the amount is small, avoid putting the chip in acid or an alkali solution, heating it over 200 °C or putting it into your mouth.

#### (3) Avoid surge current or electrostatic discharge

The LD may be damaged or deteriorated by its own strong light if a large current is supplied to it, even if only a short time.

Since the semiconductor laser may be damaged easy by electrostatic generating, be careful to avoid the happening during handling pick-up.

To connect working table using avoidable electrostatic mat and chassis of this to earth line between high resistor (1MΩ extent).

To connect working human wrist attaching least strap to earth line between high resistor (1MΩ extent).

Be sure that there is no soldering short for avoiding electrostatic damage at this laser pick-up.

### 3. 2 Axis Actuator

#### (1) Actuator

The performance of the actuator may be effected if magnetic material is located nearby, since the actuator has a strong magnetic circuit. Do not permit dust to enter through the clearance of the cover.

#### (2) Cleaning the lens

### 4. Metal Bearing

As the metal bearing of Cu-compound sintered alloy is impregnated with FROIL946P, never fail to supply the bushing with the same lubricant at the time of replacing the pick-up.

### 5. Handling

Please handle the laser pick-up with holding the slide base. (rosin molded part).

When either a part of human body or some other things may happen to touch directly with the circuit part of P.W.Board, it may cause deterioration, take careful attention in handling this base.

## CONFIRMING THE SERVO

A microcomputer adopted in this unit has the service programs so that each servo adjustment can be performed easily by the operating buttons.

This unit which adopted digital servo has the ability to automatically adjust Focus Gain, Focus Balance, Focus Offset, Tracking Gain, Tracking Balance, and Tracking Offset.

### 1. Actuating the Service Program





(1) Close the disc holder and turn power switch OFF.

(2) While pressing switch SW701 which is on the Main P.W.Board, turn power switch ON.

(Service program start actuates and displays track number 0 1.

**Note:** The operating button do not function when service program actuates.

### 2. Operating Function at Service Program Actuation

Button Operation	Function	Description																					
 OPEN/CLOSE	Opens or closes the disc holder.	<ul style="list-style-type: none"> <li>• Opens or closes when disc is stopped.</li> <li>• Operates other keys after open or close.</li> </ul>																					
 STOP	Stops system operation.	<ul style="list-style-type: none"> <li>• Displays track number 0 1.</li> <li>• Press when adjustment completed or correcting it.</li> </ul>																					
 PLAY	Operates the Focus servo and turns disc.	<ul style="list-style-type: none"> <li>• Displays track number 0 2 when operation is completed.</li> </ul>																					
 ◀◀	Performs Focus servo, Tracking servo, Slide servo, Spindle servo and various automatically adjustment.	<ul style="list-style-type: none"> <li>• Performs Tracking servo and Slide servo when pressing PLAY button.</li> <li>• Displays track number 0 3 when operation is completed.</li> <li>• When unusualness is existed, displays index number (error message). But E 9 , E - is not error message.</li> </ul>																					
 ▶▶	Displays automatically adjustment effect of EG, FBAL, FOFS, TG, TBAL and TOFS.	<ul style="list-style-type: none"> <li>• Press ■ button when ◀◀ button operation is completed.</li> <li>• When pressing ▶▶ button every once, displays automatically adjusting value about FG, FBAL, FOFS, TG, TBAL, and TOFS in the sequence.</li> <li>• Displays following indication:</li> </ul> <table style="margin-left: auto; margin-right: auto;"> <thead> <tr> <th></th> <th>INDEX</th> <th>TIME</th> </tr> </thead> <tbody> <tr> <td>FG</td> <td>0 1</td> <td>XXnXXs</td> </tr> <tr> <td>FBAL</td> <td>0 2</td> <td>XXnXXs</td> </tr> <tr> <td>FOFS</td> <td>0 3</td> <td>XXnXXs</td> </tr> <tr> <td>TG</td> <td>0 4</td> <td>XXnXXs</td> </tr> <tr> <td>TBAL</td> <td>0 5</td> <td>XXnXXs</td> </tr> <tr> <td>TOFS</td> <td>0 6</td> <td>XXnXXs</td> </tr> </tbody> </table>		INDEX	TIME	FG	0 1	XXnXXs	FBAL	0 2	XXnXXs	FOFS	0 3	XXnXXs	TG	0 4	XXnXXs	TBAL	0 5	XXnXXs	TOFS	0 6	XXnXXs
	INDEX	TIME																					
FG	0 1	XXnXXs																					
FBAL	0 2	XXnXXs																					
FOFS	0 3	XXnXXs																					
TG	0 4	XXnXXs																					
TBAL	0 5	XXnXXs																					
TOFS	0 6	XXnXXs																					
Other Buttons	No normal operation.	<ul style="list-style-type: none"> <li>• Do not operate other button except above.</li> <li>• When an error occurs, immediately turn power switch OFF.</li> </ul>																					

**Note:** Do not use remote control during service program operation.

### 3. Confirming Method

- (1) Required Measuring Equipments for adjustment
  - 1. Dual-trace oscilloscope
  - 2. Adjustment disc "Yasuko TOMITA" (CA-1094)
- (2) Adjustment location

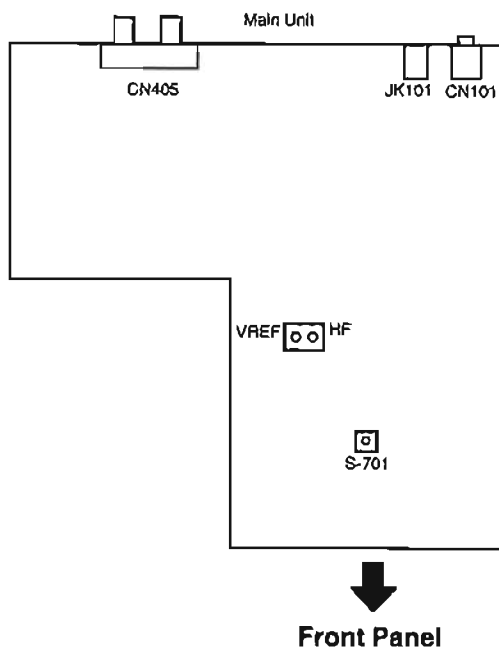

- (1) Confirming procedure
  - 1. Actuate service program.
  - 2. Load adjustment disc "Yasuko TOMITA" (CA-1094).
  - 3. When pressing ◀◀ button, confirm error message (refer to table1).
  - 4. Press ■ button.
  - 5. When pressing ▶▶ button every once, confirm automatically adjusting values about FG, FBAL, FOFS, TG, TBAL and TOFS (refer to table 2 within the limits of value).
  - 6. When service program is completed, return to normal mode (turn power switch ON).
  - 7. Confirm HF level.

(4) Error message confirmation

- 1. When pressing ◀◀ button, displays track number 03 .
- 2. Confirm error message with index number indication

TRACK INDEX      TRACK INDEX      TRACK INDEX

- (a) 03 E-
- (b) 03 E9
- (c) 03 no display

Defect is existing except above Indication.

If an error occurs, the error message is displayed as following.

**Error Message Table (table 1)**



Indication		Contents
TRACK	INDEX	
03	E 1	Unable to adjust tracking offset
03	E 2	Unable to adjust focus offset
03	E 3	Unable to adjust focus gross gain

- (5) Confirm automatically adjustment values about FG, FBAL, FOFS, TG, TBAL and TOFS.
- (1) Press ◀◀ button, displays track number 03.
  - (2) Press ■ button, displays track number 01.
  - (3) Press ▶▶ button, displays FG (Focus Gain Tentative) value, confirm the value within the limits of table 2.
  - (4) Press ▶▶ button, displays FBAL (Focus balance) value, confirm the value within the limits of table 2.
  - (5) Press ▶▶ button, displays FOFS (Focus offset) value, confirm the value within the limits of table 2.
  - (6) Press ▶▶ button, displays TG (Tracking Gain Tentative) value, confirm the value within the limits of table 2.
  - (7) Press ▶▶ button, displays TBAL (Tracking Balance) value, confirm the value within the limits of table 2.
  - (8) Press ▶▶ button, displays TOFS (Tracking Offset) value, confirm the value within the limits of table 2.

**Confirming Table about Digital Servo Adjusting Value (table 2)**

	TRACK INDEX	XXMXXS
FG	01 <u>01</u>	M88s~5M12s
FBAL	01 <u>02</u>	-1M28s~1M27s
FOFS	01 <u>03</u>	-M35s~M35s
TG	01 <u>04</u>	M94s~6M12s
TBAL	01 <u>05</u>	-1M28s~1M02s
TOFS	01 <u>06</u>	-M15s~M15s

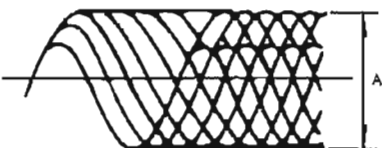
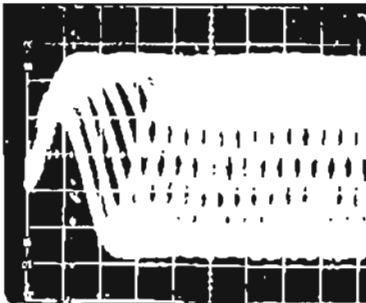
(6) HF level Confirming

Oscilloscope		Check	Step				
<table border="1"> <tr> <th>V</th> <th>H</th> </tr> <tr> <td>50mV/div or 20mV/div</td> <td>0.2μs/div or 0.5μs/div</td> </tr> </table>		V	H	50mV/div or 20mV/div	0.2μs/div or 0.5μs/div	 <p style="text-align: center;">A=0.40~0.85V</p>  <p style="text-align: center;">Eye Pattern</p>	<ol style="list-style-type: none"> <li>1. Press  button.</li> <li>2. Check HF level with oscilloscope.</li> <li>3. Confirm that the waveform is in good shape. (◇ eye pattern in center must be able to discriminate clearly.)</li> </ol>
V	H						
50mV/div or 20mV/div	0.2μs/div or 0.5μs/div						
<ul style="list-style-type: none"> <li>• Set input mode to ALTERNATE or CHOPPER.</li> </ul>							

Connection

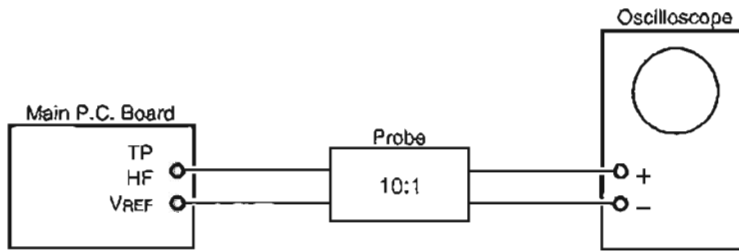



C TERMINAL FUNCTION LIST

ID6433723\*\*\*F

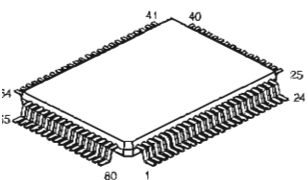

RE : RESET  
 IO : I/O  
 TY : TYPE  
 A: standard input  
 B: standard input/output  
 C: high withstand voltage  
 D: P-ch open, drain high withstand voltage  
 AC : ACTIVE  
 IN : INITIALIZE  
 External attachment : P.DG. is pull down to GND.  
 attachment : P.D. is pull down to VDISP.

ID6433723\*\*\*F Terminal Function

PIN	Terminal Name	Symbol	I/O	TY	RE	IN	AC	External attachment	Function
1	P04/AN4	SWCL	I	A	HZ	---	L	P.P.U	Door close detecting switch signal input (H: OFF, L: ON)
2	P06/AN6	SWOP	I	A	HZ	---	L	P.P.U	Door open detecting switch signal input (H: OFF, L: ON)
3	P05/AN5	FUNC2	I	A	HZ	---	---	P.P.U	Input shifting switch signal input 2 (H: OPT, L: CD)
4	P07/AN7	FUNC1	I	A	HZ	---	---	P.P.U	Input shifting switch signal input 1 (H: CD or OPT, L: COAX)
5	AVss	AVss	---	---	---	---	---	---	Ground for system
6	TEST	TEST	---	---	---	---	---	---	Ground for system
7	X2	X2	---	---	---	---	---	---	Open (Not used).
8	X1	X1	---	---	---	---	---	---	Connect with power supply (+5V) for system.
9	Vss	Vss	---	---	---	---	---	---	Ground for system
10	OSC1	OSC1	I	---	---	---	---	---	Ceramic oscillator input terminal (4.23 MHz)
11	OSC2	OSC2	O	---	---	---	---	---	Ceramic oscillator output terminal (4.23 MHz)
12	RES	RESET	I	---	---	---	L	---	Reset signal input (stable oscillation time: 40 msec)
13	P10/RQ6	REMOTE	I	B	HZ	---	---	P.P.U	Remote control input
14	P11/RQ7	SENS	I	B	HZ	---	HL	---	DSP SENS signal detection
15	P12/RQ8	RSTA	O	B	HZ	H	H	P.P.U	Reset signal output for alpha processor
16	P13/RQ9	AMUTE	O	B	HZ	H	H	P.P.U	Analog mute signal output
17	P14/RQ1	BLKCK	I	B	HZ	H	L	---	Sub code block interruption signal input
18	P15/RQ2	DOM	O	B	HZ	H	H	P.P.U	Signal output for digital data inputs
19	P16/EVENT	DF DET	I	A	HZ	---	L	---	RF detection signal input
20	P20/FS27	HC	O	D	HZ	H	---	---	Open (Not used).
21	P21/FS28	SER2	I	D	HZ	---	---	---	YM3623B fs detection input 2
22	P22/FS29	SER1	I	D	HZ	---	---	---	YM3623B fs detection input 1
23	P23/FS24	ERR	I	D	HZ	---	---	---	YM3623B error input
24	P27/FS23	DEP	I	D	HZ	---	---	---	YM3623B emphasis ON/OFF input
25	P28/FS22	FLOCK	I	D	HZ	---	L	---	Focus servo lead-in signal (L: lead-in)
26	P29/FS21	TLOCK	I	D	HZ	---	L	---	Tracking servo lead-in signal (L: lead-in)
27	P24/FS20	STAT	I	D	HZ	L	---	---	Status signal
28	P25/FS18	CRC	I	D	HZ	L	H	---	Sub code CRC result (H: OK, L: NG)
29	P26/FS19	CLVS	I	D	HZ	L	H	---	Spindle servo phase synchronous signal (H: CLV)
30	P41/FS17	DEMPH	I	D	HZ	L	H	---	MN662320 emphasis ON/OFF input (H: ON)

PIN	Terminal Name	Symbol	I/O	TY	RE	IN	AC	External attachment	Function
31	P40/FS16	INMOST	I	D	HZ	---	---	P.U.P	Pick up inner circle detecting switch signal (L: ON)
32	P60/FS15	OPT/COAX	O	D	HZ	L	---	P.DG	DA input source selection input 1 (H: OPT, L: COAX)
33	P51/FS14	CO/AUX	O	D	HZ	L	---	P.DG	DA input source selection input 2 (H: AUX, L: CD)
34	P52/FS13	S1	O	D	HZ	L	H	P.D	FL segment S1 (e)
35	P53/FS12	S2	O	D	HZ	L	H	P.D	FL segment S2 (d)
36	P54/FS11	S3	O	D	HZ	L	H	P.D	FL segment S3
37	P55/FS10	S4	O	D	HZ	L	H	P.D	FL segment S4
38	P56/FS9	S5	O	D	HZ	L	H	P.D	FL segment S5
39	P57/FS8	S6	O	D	HZ	L	H	P.D	FL segment S6 (c)
40	P17/Vdisp	VDISP	I	C	---	---	---	---	Connect with -24V.
41	P66/FD0/FS7	S7	O	D	HZ	L	H	P.D	FL segment S7 (g)
42	P67/FD1/FS8	S8	O	D	HZ	L	H	P.D	FL segment S8 (f)
43	P68/FD2/FS9	S9	O	D	HZ	L	H	P.D	FL segment S9 (b)
44	P69/FD3/FS4	S10	O	D	HZ	L	H	P.D	FL segment S10 (e)
45	P64/FD4/FS11	S11	O	D	HZ	L	H	P.D	FL segment S11
46	P65/FD5/FS2	S12	O	D	HZ	L	H	P.D	FL segment S12
47	P66/FD6/FS1	G1	O	D	HZ	L	H	P.D	FL digit G1
48	P67/FD7/FS0	G2	O	D	HZ	L	H	P.D	FL digit G2 (SEC-L)
49	P70/FD8	G3	O	D	HZ	L	H	P.D	FL digit G3 (SEC-H)
50	P71/FD9	G4	O	D	HZ	L	H	P.D	FL digit G4 (MIN-L)
51	P72/FD10	G5	O	D	HZ	L	H	P.D	FL digit G5 (MIN-H)
52	P73/FD11	G6	O	D	HZ	L	H	P.D	FL digit G6 (INDEX-L)
53	P74/FD12	G7	O	D	HZ	L	H	P.D	FL digit G7 (INDEX-H)
54	P75/FD13	G8	O	D	HZ	L	H	P.D	FL digit G8 (TRACK-L)
55	P76/FD14	G9	O	D	HZ	L	H	P.D	FL digit G9 (TRACK-H)
56	P77/FD15	G10	O	D	HZ	L	H	P.D	FL digit G10
57	Vcc	+5V	I	---	---	---	---	---	Connect with power supply (+5V) for system
58	P86	VR DN	O	B	HZ	H	L	---	Signal output for power supply volume control
59	P81	VR UP	O	B	HZ	H	L	---	Signal output for power supply volume control
60	P82	CLOSE	O	B	HZ	H	L	P.U.P	Signal output terminal for loader close
61	P80	OPEN	O	B	HZ	H	L	P.U.P	Signal output terminal for loader open
62	P84	OMOOR	O	B	HZ	H	H	---	Mute selection output terminal for SM5845 digital output (H: ON, L: OFF)
63	P85	SHIFT	O	B	HZ	H	L	---	Output terminal for SM5845 alpha test terminal 2 (H: OFF, L: ON)
64	P88	MAINS	O	B	HZ	H	H	---	Output terminal for SM5845 alpha test terminal 1 (H: OFF, L: ON)
65	P87	DMUTE	O	B	HZ	H	H	P.U.P	Signal output for digital mute (H: ON, L: OFF)
66	P89/PWM	INV	O	B	HZ	H	L	---	Digital audio polarity switching signal output
67	P91/SCK1	MCLK	O	B	HZ	H	T	---	MN662720 control clock output terminal
68	P89/S11	MLED	O	B	HZ	H	L	---	MN662720 control latch output terminal
69	P92/SO1	MDATA	O	B	HZ	H	---	---	MN662720 control data output terminal
70	P93/SCK2	SOCK	O	B	HZ	H	T	---	Clock output terminal for sub code reading
71	P92/SB2/SCK3	SUBCO	I	B	HZ	H	---	---	Sub code data signal input terminal
72	P93/SO2	RST	O	B	HZ	L	L	P.DG	Peripheral LSI reset signal output
73	P97/UD	MCK	O	B	HZ	H	T	---	Microcomputer data clock output terminal for SM5845
74	PA0	MDT	O	B	HZ	H	---	---	Microcomputer data output terminal for SM5845
75	PA1	MLEN	O	B	HZ	H	T	---	Microcomputer data latch enable output terminal for SM5845
76	AVcc	+5V	I	---	---	---	---	---	Connect with power supply (+5V) for system
77	P00/AN0	D0	I	A	HZ	---	---	P.U.P	Key data input 0 (A/D)
78	P01/AN1	D1	I	A	HZ	---	---	P.U.P	Key data input 1 (A/D)
79	P02/AN2	D2	I	A	HZ	---	---	P.U.P	Key data input 2 (A/D)
80	P03/AN3	D3	I	A	HZ	---	---	P.U.P	Key data input 3 (A/D)





MN662720

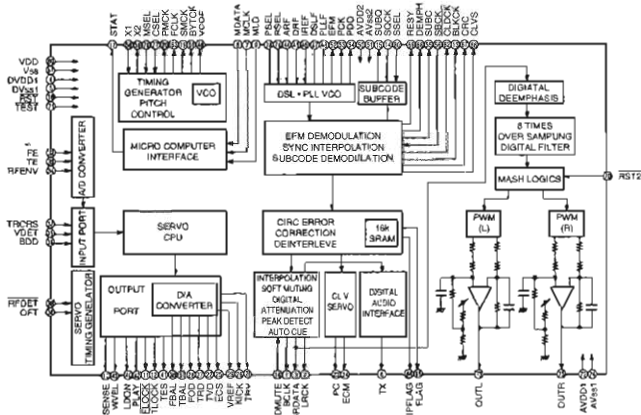
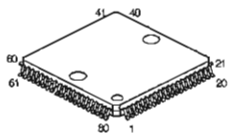

MN662720 Terminal Function

Pin No	Function	I/O	Function
1	BCLK	O	Bit clock output for SRDATA.
2	LRCK	O	L/R discriminating signal output.
3	SRDATA	O	Serial data output.
4	DVDD1	I	Power supply for digital circuit.
5	DVSS1	I	Ground for digital circuit.
6	TX	O	Digital audio interface signal output.
7	MCLK	I	Microcomputer command clock signal input (Latch data with leading edge).
8	MDATA	I	Microcomputer command data input.
9	MLD	I	Microcomputer command load signal input ("L": Load).
10	SENSE	O	Sense signal output (OFT, FESL, NACEND, NAJEND, POSAD and SFG).
11	FLOCK	O	Focus servo Lead-in signal ("L": Lead-in state).
12	TLOCK	O	Tracking servo Lead-in signal ("L": Lead-in state).
13	BLKCK	O	Subcode block clock signal (Fblkck=75Hz).
14	SOCK	I	External clock input for subcode Q register.
15	SUBO	O	Subcode Q code output.
16	DMUTE	I	Muting input ("H": Mute).
17	STAT	O	Status signal (CRC, CUE, CLVS, TTSTOP, FCLV and SOOK).
18	RST	I	Reset input ("L": Reset).
19	SMCK	O	8.4672MHz clock signal output at MSEL="H" 4.2336MHz clock signal output at MSEL="L"
20	PMCK	O	88.2kHz clock signal output.
21	TRV	O	Traverse forced feed output.
22	TVD	O	Traverse drive output.
23	PC	O	Spindle motor ON signal ("L": ON).
24	ECM	O	Spindle motor drive signal (Force mode output). 3-state.
25	ECS	O	Spindle motor drive signal (Servo error signal output).
26	KICK	O	Kick pulse output.
27	TRD	O	Tracking drive output.
28	FOD	O	Focus drive output.
29	VREF	I	Reference voltage for DA output portion (TVD, ECS, TRD, FOD, FBAL, and TBAL).
30	FBAL	O	Focus balance adjusting output.
31	TBAL	O	Tracking balance adjusting output.
32	FE	I	Focus error signal input (Analog input).
33	TE	I	Tracking error signal input (Analog input).
34	RFENV	I	RF envelope signal input (Analog input).
35	VDET	I	Oscillating detection signal input ("H": detecting).
36	OFT	I	Offtrack signal input ("H": Offtrack).
37	TRCRS	I	Track cross signal input.
38	RFDET	I	RF detecting signal input ("L": detecting).
39	BOO	I	Drop out signal input ("H": Drop out).
40	LDON	O	Tracking error shunt signal output ("H": ON).
41	TES	O	Tracking error shunt signal output ("H": shunt).
42	PLAY	O	Play signal output ("H": play).
43	WVCL	O	Double speed status signal output.
44	ARF	I	RF signal input.
45	IREF	I	Reference current input terminal.
46	DRF	I	Bias terminal for DSL.
47	DSLIF	I/O	Loop filter terminal for DSL.
48	PLIF	I/O	Loop filter terminal for PLL.
49	VCOF	I/O	Loop filter terminal for VCO.
50	AVDD2	I	Power supply for analog circuit (for DSL, PLL and DA output sections).

Pin No	Function	I/O	Function
51	AVSS2	I	Ground for analog circuit (for DSL, PLL and DA output sections).
52	EFM	O	EFM signal output.
53	PCK	O	PLL extract clock output (Fpck=4.321MHz).
54	PDO	O	Phase comparing signal output when compared EFM signal and PCK signal.
55	SUBC	O	Subcode serial data output.
56	SBCK	I	Clock input subcode serial output.
57	VSS	I	Ground for oscillating circuit.
58	X1	I	Crystal oscillating circuit input terminal. (f=16.9344MHz).
59	X2	O	Crystal oscillating circuit output terminal (f=16.9344MHz)
60	VDD	I	Power supply for oscillating circuit.
61	BYTCK	O	Byte clock output.
62	CLDCK	O	Subcode frame clock signal output (Fclck=7.35kHz).
63	FCLK	O	Crystal frame clock output (Ffclk=7.35kHz).
64	IPFLAG	O	Interpolation flag output ("H": interpolation).
65	FLAG	O	Flag output.
66	CLVS	O	Spindle servo phase synchronous state signal output ("H": CLV, "L": Rough servo).
67	CRC	O	Subcode CRC check result output ("H": OF, "L": NG).
68	DEMPH	O	Deemphasis detecting signal output ("H": ON).
69	RESY	O	Re-synchronous signal output of frame synchronous ("H": synchronous, "L": synchronous come off).
70	RST2	I	Reset terminal for stopped MASH circuit ("L": Reset).
71	TEST	I	Test terminal (normally "H").
72	AVDD1	I	Power supply for analog circuit (Audio output using both as Lch and Rch).
73	OUTL	O	Lch output.
74	AVSS1	I	Ground for analog circuit (Audio output using both as Lch and Rch).
75	OUTR	O	Rch output.
76	RSEL	I	RF signal polarity selective terminal (RSEL="H" at brightness level "H". RSEL="L" at brightness level "L").
77	CSEL	I	Crystal oscillating frequency selective terminal (normally "L").
78	PSEL	I	Test terminal (normally "L").
79	MSEL	I	SMCK and frequency shifting output terminal ("H": SMCK=8.4672MHz, "L": SMCK=4.2336MHz).
80	SSEL	I	SUBQ and mode shifting output terminal ("H": Q code buffer using mode).

AN8805SB

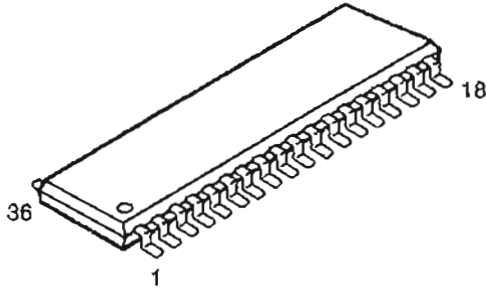

AN8805SB Terminal Function

Pin No	Symbol	I/O	Function
1	PD	I	PD signal input for output monitor of LD.
2	LD	O	Connect to external transistor's base for LD drive.
3	LDON	I	LD APC ON/OFF switching signal.
4	C.CRS	—	Capacitor connecting terminal for CROSS.
5	VCC	—	Power supply connecting terminal.
6	RF	I	RF AMP reversal input terminal. Connect a resistor.
7	RFOUT	O	RF AMP output terminal (reversal AMP).
8	RFIN	I	Input terminal of RF AGC.
9	C. AGC	—	Capacitor connecting terminal for RF AGC loop filter.
10	ARF	O	RF output terminal of after AGC.
11	C. ENV	—	Capacitor connecting terminal for RF.
12	C. EA	—	Capacitor connecting terminal for AMP.
13	C. SBDO	—	Capacitor connecting terminal for low speed detection of dark level DO detection.
14	BDO	O	BDO detection output terminal. Positive logic.
15	C. SBRT	—	Capacitor connecting terminal for low speed detection of OFTR detection.
16	OFTR	O	Output terminal of OFF TRACK detection. Positive logic.
17	NRFDET	O	Output terminal of RF signal amplitude detection. Negative logic.
18	GND	—	GND
19	ENV	O	ENV output terminal.
20	VREF	O	VCC x 0.5(V) output terminal.
21	LD OFF	I	Input terminal of LD APC forcible stop.
22	VDET	O	Output terminal of vibration detection.
23	TEBPF	I	Input terminal of vibration detection.
24	CROSS	O	Output terminal of TE CROSS detection signal.
25	TEOUT	O	Output terminal of TEAMP.
26	TE	I	TEAMP reversal input terminal. Connect a resistor.
27	FEOUT	O	Output terminal of FEAMP.
28	FE	I	FEAMP reversal input terminal. Connect a resistor.
29	FBAL	I	Control signal input terminal of FO balance adjustment.
30	TBAL	I	Control signal input terminal of TE balance adjustment.
31	PDFR	—	Resistor connecting terminal for setting IV converting resistance value of PDE.
32	PDER	—	Resistor connecting terminal for setting IV converting resistance value of PDF.
33	PDE	I	Connect to PIN diode E.
34	PDF	I	Connect to PIN diode F.
35	PDBD	I	Connect to B, D of astigmatism 1/4 divided PD.
36	PDAC	I	Connect to A, C of astigmatism 1/4 divided PD.

AN8389S

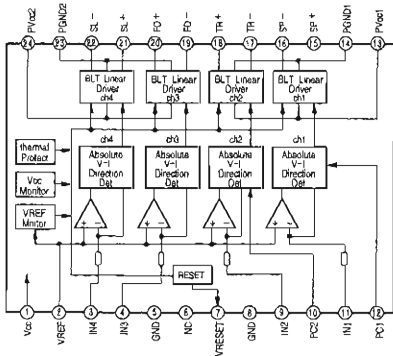
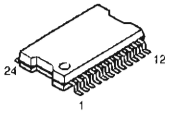

AN8389S Terminal Function

Pin No.	Symbol	I/O	DC Voltage (Vcc/BV)	Equivalent Circuit Diagram	Function
1	SVoc	I	8V		SVoc terminal for driver control circuit, not connected to power Vcc terminal.
2	Vref	I	2.5V		Vref input terminal.
3	IN4	I	2.5V		Driver 4 error input terminal
4	IN3	I	2.5V		Driver 3 error input terminal
5	SGND	I	0V		SGND terminal for driver control circuit.
6	NC				
7	NRESET	O	—		Reset output terminal
8	SGND	I	0V		SGND terminal for driver control circuit

Pin No.	Symbol	I/O	DC Voltage (Vcc/BV)	Equivalent Circuit Diagram	Function
9	IN2	I	2.5V		Driver 2 error input terminal
10	PC2	I	0V		Control power cutting input terminal to  and  output
11	IN1	I	2.5V		Driver 1 error input terminal.
12	PC1	I	0V		Control power cutting input terminal to  and  output.
13	PVcc1	I	8V		Supply current feeding  -  power output transistor from Vcc power supply terminal.
14	PGND1	I	0V		P GND terminal for  -  output transistor.
15	D1 -	O	0V		Driver 1 inverting output terminal
16	D1 +	O	0V		Driver 1 noninverting output terminal.
17	D2 -	O	0V		Driver 2 inverting output terminal.
18	D2 +	O	0V		Driver 2 noninverting output terminal
19	D3 -	O	0V		Driver 3 inverting output terminal.
20	D3 +	O	0V		Driver noninverting output terminal.
21	D4 -	O	0V		Driver 4 noninverting output terminal.
22	D4 +	O	0V		Driver 4 noninverting output terminal.
23	PGND2	I	0V		P GND terminal for  -  output transistor.
24	PVcc2	I	8V		Supply current feeding  -  power output transistor from Vcc power supply terminal.

SEMICONDUCTORS

● IC's

SM5845-AF

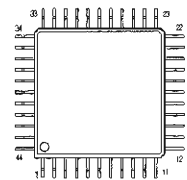

PCM1702P

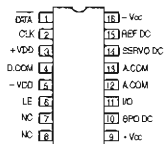

TC74HCU04AP

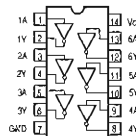
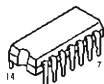

BA15218  
NE5532  
NJM4556AD  
μPC4570C

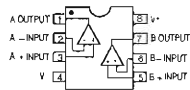

NJM79M12FA

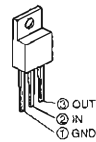

NJM7805FA (S)  
NJM7806FA (S)  
NJM7812FA

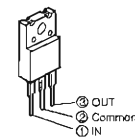

PST529C

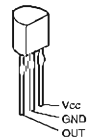

NJM7905FA

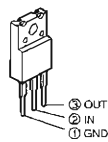

NJM78L05A

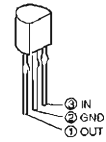

ICP-N15  
ICP-N20

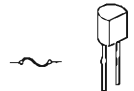

● TRANSISTORS

2SA933 (R/S)  
2SD2878 (A/B)

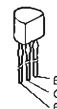

2SB562 (C)  
2SD488 (C)

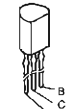

2SB1185(E/F)

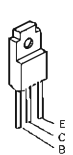

RN1202 (10k-10k) NPN  
RN2202 (10k-10k) PNP

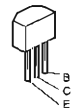

RN1202

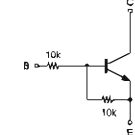

RN2202

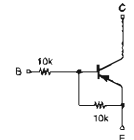

DTA144EK  
DTC144EK



1: E/GND  
2: B/N  
3: C/OUT

DTC144EK  
NPN Type

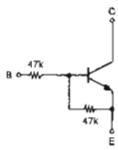

DTA144EK  
PNP Type

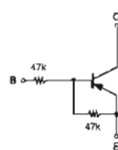

● DIDODES (Including LED)

1SR35-200A

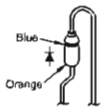

1SS270A

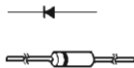

S2K20F



PRINTED WIRING BOARD

1 2 3 4 5 6 7 8

1U-3058 MAIN P.W.B. UNIT

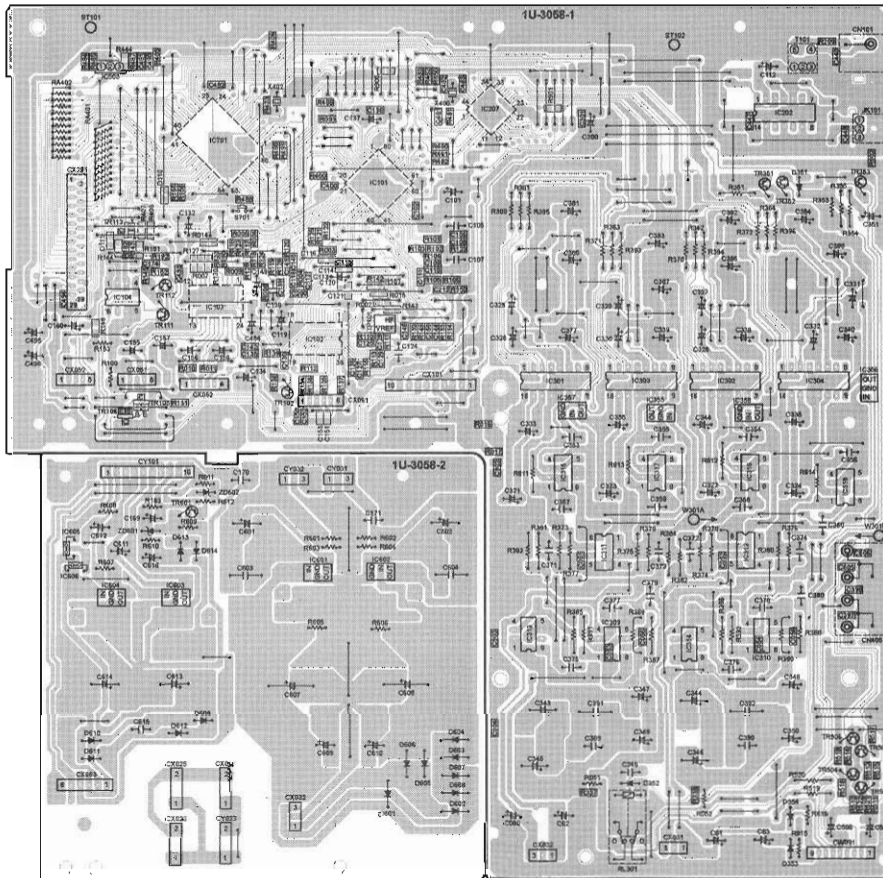





**NOTE FOR PARTS LIST**

- Part indicated with the mark "O" are not always in stock and possibly to take a long period of time for supplying, or in some cases supplying of part may be refused.
  - When ordering of part, clearly indicate "1" and "1" (l) to avoid mis-supplying.
  - Ordering part without stating its part number can not be supplied.
  - Part indicated with the mark "e" is not illustrated in the exploded view.
  - Not including Carbon Film ±5%, 1/4W Type in the P.W.Board parts list. (Refer to the Schematic Diagram for those parts)
- WARNING:**  
Parts marked with this symbol  $\Delta$  have critical characteristics.  
Use ONLY replacement parts recommended by the manufacturer.

**Resistors**

Ex.	RM	14K	2E	182	G	FR	Others
Type	Shape	Power	Resist- ance	Allowable error	Others	Others	Others
RD	Carbon	2W	1000	±1%	P	Thin-film resistor type	
RC	Composition	2E	1000	±5%	RL	Low noise type	
RE	Metal oxide film	2W	1000	±5%	RB	Non-burning type	
RF	Wirewound	2W	1000	±1%	RC	Four-terminal	
RG	Metal film	2W	1000	±1%	RD	Lead wire forming	
RH	Metal resistor	2W	1000	±1%	RE	Lead wire forming	

**Capacitors**

Ex.	CE	04W	1H	2R2	M	BP	Others
Type	Shape	and per- formance	Dielectric	Capacity	Allowable error	Others	Others
CE	Aluminum foil electrolytic	1A: 10V	J: ±5%	HS	High stability type		
CA	Aluminum electrolytic	1A: 10V	J: ±5%	SP	Non-polar type		
CB	Tantalum electrolytic	1C: 16V	J: ±5%	SR	Ripple-resistant type		
CC	Film	1E: 50V	K: ±10%	SS	For charge and discharge		
CD	Ceramic	1V: 35V	M: ±20%	HF	For assuring high frequency		
CE	Ceramic	1H: 50V	Z: ±80%	U	UL part		
CF	CF	2A: 100V	-20%	C	CSA part		
CG	Mica	2B: 125V	P: ±100%	W	UL-CSA type		
CH	Metalized	2C: 100V	-5%	F	Lead wire forming		
CI	Metalized	2D: 100V	G: ±0.25%				
CJ	Metalized	2E: 100V	D: ±0.5%				
CK	Metalized	2F: 100V	-				
CL	Metalized	2G: 100V	-				

**Resistance**  
1 1 1 1800 ohm = 1.8 kohm  
Indicates number of zeros after effective number.  
2-digit effective number.

• Units: ohm

**Capacity (electrolyte only)**  
2 2 2 2000µF  
Indicates number of zeros after effective number.  
2-digit effective number.

• Units: µF

**Capacity (except electrolyte)**  
2 2 2 20000F=0.0002µF  
Indicates number of zeros after effective number.  
2-digit effective number.

• Units: pF

When the dielectric strength is indicated in AC, "AC" is included after the dielectric strength value.

**PARTS LIST OF P.W.BOARD  
1U-3058 MAIN P.W.B. UNIT A'SSY**

Ref. No.	Part No.	Part Name	Remarks	Ref. No.	Part No.	Part Name	Remarks
<b>SEMICONDUCTORS GROUP</b>				<b>RESISTORS GROUP</b>			
IC101	282 2141 002	IC MN662720		R001	247 0018 905	Carbon chip 6 ohm 1/10W	RM73B-0R0K
IC102	282 2142 904	IC AN8805S		R002	247 0011 928	Carbon chip 29 kohm 1/10W	RM73B-368J
IC103	282 2143 903	IC AN8859		R003-011	247 0018 905	Carbon chip 6 ohm 1/10W	RM73B-0R0K
IC104	263 0565 007	IC BA15218		R014-017	247 0018 905	Carbon chip 6 ohm 1/10W	RM73B-0R0K
				R051,052	241 2434 013	Carbon film 150 ohm 1/2W	FC052AH151AFRM3
IC202	282 1865 002	IC TC74HC00AAP		R100	244 2050 904	Metal oxide 22 ohm 1W	S1483A220JNBS(S)
IC207	282 1869 000	IC SM5845AF		R101	247 0007 903	Carbon chip 680 ohm 1/10W	RM73B-681J
IC301-304	282 1837 026	IC PCM1702P		R102	247 0005 988	Carbon chip 220 ohm 1/10W	RM73B-221J
IC309,310	282 2182 003	IC NE5532 (PHI)		R103	247 0012 927	Carbon chip 100 kohm 1/10W	RM73B-104J
IC311-314	283 0890 000	IC OP275GP		R104	247 0014 907	Carbon chip 1 Mohm 1/10W	RM73B-105J
IC315-318	282 0664 006	IC UPCA570C		R105	247 0011 988	Carbon chip 88 kohm 1/10W	RM73B-883J
IC385,386	283 8432 907	IC NJM79L05A		R106	247 0012 943	Carbon chip 120 kohm 1/10W	RM73B-124J
IC367,368	283 0554 008	IC NJM79S05FA		R107	247 0009 927	Carbon chip 5.6 kohm 1/10W	RM73B-562J
IC503	283 0862 907	IC PST529C		R110	247 0013 903	Carbon chip 220 kohm 1/10W	RM73B-224J
				R111	247 0011 928	Carbon chip 36 kohm 1/10W	RM73B-393J
IO801	283 0516 001	IC NJM7812FA		R112	247 0010 987	Carbon chip 27 kohm 1/10W	RM73B-273J
IO602	282 0539 004	IC NJM79M12FA		R113	247 0011 986	Carbon chip 88 kohm 1/10W	RM73B-883J
IO603	283 0793 002	IC NJM7805FA(S)		R114	247 0012 998	Carbon chip 200 kohm 1/10W	RM73B-204J
IO604	283 0809 006	IC NJM7805FA(S)		R115	247 0013 942	Carbon chip 330 kohm 1/10W	RM73B-334J
IO605,606	286 0074 904	IC ICP-420T		R116	247 0012 901	Carbon chip 82 kohm 1/10W	RM73B-823J
				R117	247 0010 945	Carbon chip 16 kohm 1/10W	RM73B-163J
IC701	262 2172 107	IC HD643372AD16F		R118	247 0011 980	Carbon chip 55 kohm 1/10W	RM73B-553J
TR102	271 0183 927	Transistor 2SA939 (P/S)		R119	247 0008 944	Carbon chip 2.7 kohm 1/10W	RM73B-272J
TR105	269 0054 901	Transistor DTC144EK		R120	247 0012 988	Carbon chip 200 kohm 1/10W	RM73B-204J
TR106	269 0055 900	Transistor DTA144EK		R121	247 0009 901	Carbon chip 4.7 kohm 1/10W	RM73B-472J
TR111	274 0035 905	Transistor 2SD486(C)		R122	247 0008 944	Carbon chip 2.7 kohm 1/10W	RM73B-272J
TR112	272 0025 907	Transistor 2SB866(C)		R123	247 0009 901	Carbon chip 4.7 kohm 1/10W	RM73B-472J
TR351	289 0026 900	Transistor FN2202(10K-10K)		R124	247 0008 931	Carbon chip 2.4 kohm 1/10W	RM73B-242J
TR352	289 0025 901	Transistor FN1202(10K-10K)		R125	247 0010 945	Carbon chip 16 kohm 1/10W	RM73B-163J
TR353	269 0026 900	Transistor FN2202(10K-10K)		R126	247 0009 985	Carbon chip 10 kohm 1/10W	RM73B-103J
TR503-508	273 0253 618	Transistor 2SC2878(A/B)		R127,128	247 0005 906	Carbon chip 100 ohm 1/10W	RM73B-101J
TR601	272 0025 907	Transistor 2SB502(C)		R131	247 0008 958	Carbon chip 10 kohm 1/10W	RM73B-103J
				R132	247 0008 958	Carbon chip 3.3 kohm 1/10W	RM73B-332J
0351-354	276 0432 803	Diode 1SS270A		R133-137	247 0019 908	Carbon chip 0 ohm 1/10W	RM73B-0R0K
D801-808	276 0348 000	Diode S2K20F		R138	247 0009 985	Carbon chip 10 kohm 1/10W	RM73B-103J
D809-814	276 0533 905	Diode 1SR35-200A		R139	247 0005 905	Carbon chip 100 ohm 1/10W	RM73B-101J
ZD801	278 0484 906	Zener diode HZS33-1	33V	R142	247 0009 927	Carbon chip 5.9 kohm 1/10W	RM73B-562J
ZD802	278 0466 906	Zener diode HZS7C-1	7V	R143	247 0007 967	Carbon chip 1.5 kohm 1/10W	RM73B-152J
				R144	247 0012 943	Carbon chip 120 kohm 1/10W	RM73B-124J
				R145	247 0005 989	Carbon chip 220 ohm 1/10W	RM73B-221J
				R147	247 0010 929	Carbon chip 15 kohm 1/10W	RM73B-153J
				R148	247 0010 916	Carbon chip 13 kohm 1/10W	RM73B-133J
				R151	247 0009 956	Carbon chip 7.5 kohm 1/10W	RM73B-752J
				R152	247 0011 998	Carbon chip 75 kohm 1/10W	RM73B-753J
				R153	244 2051 945	Metal oxide 10 ohm 1W	S1483A10JNBS(S)
				R155,158	247 0009 985	Carbon chip 10 kohm 1/10W	RM73B-103J
				R182	247 0012 943	Carbon chip 120 kohm 1/10W	RM73B-124J
				R190	247 0018 909	Carbon chip 300 kohm 1/10W	RM73B-304J
				R192	247 0008 946	Carbon chip 22 ohm 1/10W	RM73B-220J
JK101	269 0098 006	Optical connector GP1F32T	(Opt. out)				

Ref. No.	Part No.	Part Name	Remarks	Ref. No.	Part No.	Part Name	Remarks
R209	247 0004 977	Carbon chip 75 ohm 1/10W	RM73B--750J	C053--056	257 0003 933	Ceramic chip 30pF/50V	CC73SL1H300J
R337,338	247 0012 927	Carbon chip 100 kohm 1/10W	RM73B--104J	C060--063	254 4356 713	Electrolytic 100μF/50V	CE04W1H101MC (ARS)
R350	247 0009 985	Carbon chip 10 kohm 1/10W	RM73B--103J	C101	254 4356 713	Electrolytic 100μF/50V	CE04W1H101MC (ARS)
R353	244 2058 016	Metal oxide 2.2 kohm 1W	RS14B3A222JNBS (RSFSV)	C102	257 0011 996	Ceramic chip 0.1μF/25V	CK73B1E104K
R373--376	241 2423 972	Carbon film 3.6 kohm 1/4W	RD14B2E362J (PSNB)	C105	256 1035 936	Metallized 0.33μF/50V	CF93A1H334J
R377--380	241 2423 927	Carbon film 2.2 kohm 1/4W	RD14B2E222J (PSNB)	C107	256 1035 910	Metallized 0.22μF/50V	CF93A1H224J
R381,382	241 2424 942	Carbon film 6.8 kohm 1/4W	RD14B2E682J (PSNB)	C109,110	257 0011 941	Ceramic chip 0.022μF/25V	CK73B1E223K
R383,384	241 2423 972	Carbon film 3.6 kohm 1/4W	RD14B2E362J (PSNB)	C111	257 0006 943	Ceramic chip 560pF/50V	CC73SL1H561J
R385,386	241 2422 973	Carbon film 1.3 kohm 1/4W	RD14B2E132J (PSNB)	C112	254 4254 925	Electrolytic 33μF/16V	CE04W1C330M
R400	247 0007 945	Carbon chip 1 kohm 1/10W	RM73B--102J	C113	254 4260 948	Electrolytic 1μF/50V	CE04W1H010M
R405--408	247 0009 985	Carbon chip 10 kohm 1/10W	RM73B--103J	C114	257 0004 961	Ceramic chip 100pF/50V	CC73SL1H101J
R444	247 0009 985	Carbon chip 10 kohm 1/10W	RM73B--103J	C115	257 0011 954	Ceramic chip 0.027μF/25V	CK73B1E273K
R460--462	247 0007 945	Carbon chip 1 kohm 1/10W	RM73B--102J	C116,117	257 0009 924	Ceramic chip 2200pF/50V	CK73B1H222K
R481	247 0007 945	Carbon chip 1 kohm 1/10W	RM73B--102J	C118	257 0011 996	Ceramic chip 0.1μF/25V	CK73B1E104K
R482,483	247 0009 985	Carbon chip 10 kohm 1/10W	RM73B--103J	C119	254 4252 943	Electrolytic 220μF/10V	CE04W1A221M
R484	247 0018 905	Carbon chip 0 ohm 1/10W	RM73B--0R0K	C120	257 0011 996	Ceramic chip 0.1μF/25V	CK73B1E104K
R486--488	247 0009 985	Carbon chip 10 kohm 1/10W	RM73B--103J	C121	257 0001 948	Ceramic chip 2.0pF/50V	CC73SL1H2R0C
R490,491	247 0007 945	Carbon chip 1 kohm 1/10W	RM73B--102J	C124	256 1034 937	Metallized 0.047μF/50V	CF93A1H473J
R511--514	247 0005 963	Carbon chip 180 ohm 1/10W	RM73B--181J	C125	257 0009 966	Ceramic chip 4700pF/50V	CK73B1H472K
R515--518	247 0008 944	Carbon chip 2.7 kohm 1/10W	RM73B--272J	C126,127	257 0011 996	Ceramic chip 0.1μF/25V	CK73B1E104K
R521,522	247 0012 927	Carbon chip 100 kohm 1/10W	RM73B--104J	C128	257 0005 986	Ceramic chip 330pF/50V	CC73SL1H331J
R601,603	244 2068 035	Metal oxide 390 ohm 1W	RS14B3A391JNBS (RSFSV)	C129	257 0005 931	Ceramic chip 200pF/50V	CC73SL1H201J
R605	244 2058 003	Metal oxide 1 kohm 1W	RS14B3A102JNBS (RSFSV)	C130	257 0011 996	Ceramic chip 0.1μF/25V	CK73B1E104K
R606	244 2058 016	Metal oxide 2.2 kohm 1W	RS14B3A222JNBS (RSFSV)	C132	254 4254 938	Electrolytic 47μF/16V	CE04W1C470M
R811--814	241 2424 942	Carbon film 6.8 kohm 1/4W	RD14B2E682J (PSNB)	C133	257 0011 996	Ceramic chip 0.1μF/25V	CK73B1E104K
R815,816	244 2058 032	Metal oxide 47 ohm 1W	RS14B3A470JNBS (RSFSV)	C134	254 4254 938	Electrolytic 47μF/16V	CE04W1C470M
R900	247 0007 945	Carbon chip 1 kohm 1/10W	RM73B--102J	C135,136	257 0011 996	Ceramic chip 0.1μF/25V	CK73B1E104K
R901,902	247 0018 905	Carbon chip 0 ohm 1/10W	RM73B--0R0K	C137	254 4250 929	Electrolytic 100μF/6.3V	CE04W0J101M
RA401,402	246 2060 000	Metal mixture 100 kohm 1/8W	RK99--2B104JP11 (S)	C138	256 1035 907	Metallized 0.18μF/50V	CF93A1H184J
<b>CAPACITORS GROUP</b>				C139	257 0011 996	Ceramic chip 0.1μF/25V	CK73B1E104K
C051,052	257 0006 930	Ceramic chip 510pF/50V	CC73SL1H511J	C140	257 0009 908	Ceramic chip 1500pF/50V	CK73B1H152K
				C141	257 0009 995	Ceramic chip 8200pF/50V	CK73B1H822K
				C142	257 0011 996	Ceramic chip 0.1μF/25V	CK73B1E104K
				C145	257 0009 924	Ceramic chip 2200pF/50V	CK73B1H222K
				C146	257 0004 961	Ceramic chip 100pF/50V	CC73SL1H101J
				C149	254 4260 951	Electrolytic 2.2μF/50V	CE04W1H2R2M
				C150,151	257 0005 944	Ceramic chip 220pF/50V	CC73SL1H221J
				C155--158	254 3056 917	Electrolytic 1μF/50V	CE04D1H010MBP
				C169	254 4313 918	Electrolytic 10μF/50V	CE04W1H100M (ASF)
				C170,171	255 4235 934	Polypropylene film 0.01μF/100V	CQ93P2A103J (NH)
				C174	257 0011 996	Ceramic chip 0.1μF/25V	CK73B1E104K
				C246	255 4235 934	Polypropylene film 0.01μF/100V	CQ93P2A103J(NH)
				C300	254 4313 950	Electrolytic 100μF/50V	CE04W1H101M (ASF)
				C301	257 0011 996	Ceramic chip 0.1μF/25V	CK73B1E104K

Ref. No.	Part No.	Part Name	Remarks	Ref. No.	Part No.	Part Name	Remarks	Q'ty
C321~324	254 4356 726	Electrolytic 22 $\mu$ F/50V	CE04W1H220MC (ARS)	CN405	204 8507 000	4P pin jack (AU)		1
C333~336	254 4356 713	Electrolytic 100 $\mu$ F/50V	CE04W1H101MC (ARS)	CW091	204 2748 001	9P PH-SAN shielded cord		1
C337~340	254 4356 739	Electrolytic 47 $\mu$ F/50V	CE04W1H470MC (ARS)	CX024	205 0581 056	2P VH connector base		1
C343~346	254 4356 742	Electrolytic 470 $\mu$ F/50V	CE04W1H471(ARS)	CX025,026	205 0581 001	2P VH connector base		2
C351	254 4488 704	Electrolytic 220 $\mu$ F/25V	CE04W1E221MC (ARD)	CX031	205 0277 030	3P EH connector base (RD)		1
C353~356	255 4235 921	Polypropylene film 270pF/100V	CQ93P2A271J(NH)	CX032	205 0233 032	3 P EH connector base		1
C357~360	255 4235 918	Polypropylene film 100pF/100V	CQ93P2A101J(NH)	CX035	205 0190 036	3P NH connector base		1
C371,372	255 4232 911	Polypropylene film 180pF/100V	CQ93P2A181J(NH)	CX051	205 0343 058	5P connector base(KR-PH)		1
C373,374	255 4232 908	Polypropylene film 820pF/100V	CQ93P2A821J(NH)	CX052	205 0321 054	5P connector base (RED)		1
C375~380	255 4237 903	Polypropylene film 2700pF/100V	CQ93P2A272J(NH)	CX061	205 0343 061	6P connector base(KR-PH)		1
C381~388	254 4356 739	Electrolytic 47 $\mu$ F/50V	CE04W1H470MC (ARS)	CX062	205 0321 067	6P connector base (RED)		1
C391,392	256 1054 001	Metalized 1 $\mu$ F/50V	CF93B1H105K(GSG)	CX063	205 0190 065	6P NH connector base		1
C397,398	257 0006 927	Ceramic chip 470pF/50V	CC73SL1H471J	CX101	205 0275 003	10P EH connector base		1
C400	257 0004 961	Ceramic chip 100pF/50V	CC73SL1H101J	CX291	205 0549 027	29P FFC connector base		1
C440	257 0011 996	Ceramic chip 0.1 $\mu$ F/25V	CK73B1E104K	CY023	205 0581 085	2P VH connector base		1
C447,448	257 0011 996	Ceramic chip 0.1 $\mu$ F/25V	CK73B1E104K	CY031	205 0277 030	3P EH connector base (RD)		1
C481	257 0007 900	Ceramic chip 1000pF/50V	CC73SL1H102J	CY032	205 0233 032	3 P EH connector base		1
C482,483	257 0002 921	Ceramic chip 10pF/50V	CC73SL1H100D	CY101	205 0275 003	10P EH connector base		1
C484	254 4260 948	Electrolytic 1 $\mu$ F/50V	CE04W1H010M	RL301	214 0127 003	Relay (RY-12W)		1
C490,491	257 0010 900	Ceramic chip 0.01 $\mu$ F/50V	CK73B1H103K	S701	212 5604 907	Tact switch -TA (ALPS)		1
C492~494	257 0011 996	Ceramic chip 0.1 $\mu$ F/25V	CK73B1E104K	ST103	205 0452 017	Style pin		1
C495,496	254 4258 934	Electrolytic 33 $\mu$ F/35V	CE04W1V330M	T101	231 8063 009	Pulse trans.		1
C505,506	254 4356 739	Electrolytic 47 $\mu$ F/50V	CE04W1H470MC (ARS)	TP101	205 0190 023	2P NH connector base		1
C601,602	254 4515 703	Electrolytic 470 $\mu$ F/50V	CE04W1H471MC (ARS2)	W301	203 0467 064	1P SIN con. Ass'y		1
C603,604	256 1045 036	Metalized 1 $\mu$ F/63V	CF93B1J105K(SAG)	X400	399 0165 007	Crystal 16.9344 MHz		1
C605,606	257 0006 943	Ceramic chip 560pF/50V	CC73SL1H561J		417 0307 011	Heat sink		2
C607,608	254 4356 771	Electrolytic 3300 $\mu$ F/50V	CE04W1H332MC (ARS)		471 3304 015	Screw 3 8 CBS-Z		4
C611,612	254 4313 989	Electrolytic 33 $\mu$ F/50V	CE04W1H330M (ASF)					
C613,614	254 4319 789	Electrolytic 3300 $\mu$ F/25V	CE04W1E332MC (ASF)					
C615	255 4235 934	Polypropylene film 0.01 F/100V	CQ93P2A103J(NH)					
C616	254 4367 906	Electrolytic 47 $\mu$ F/63V	CE04W1J470M(ASF)					

J-3059 DISPLAY P.W.B. UNIT A'SSY

Ref. No.	Part No.	Part Name	Remarks
<b>SEMICONDUCTORS GROUP</b>			
IC501	283 0995 004	IC NJM4568AD	
IC502	283 0665 007	IC BA15218	
IC501	489 0260 007	Retrocon sensor GP1U271X	
TR500_501	273 0253 918	Transistor 2SC2878(AE)	
<b>RESISTORS GROUP</b>			
VR501	211 0764 001	Variable resistor 20 kohm	V0620FA203
<b>CAPACITORS GROUP</b>			
C601,602	253 1117 907	Ceramic 270 pF/50V	CK451H272K
C503	254 4452 701	Electrolytic 470µF/16V	CE04W1C471MC (ASF)
C504	254 4452 714	Electrolytic 220µF/16V	CE04W1C222MC (ASF)
C650	253 9014 702	Ceramic 0.01µF/400V(AC)	CK45F2GAC103MG
<b>OTHER PARTS GROUP</b>			
			<b>Qty</b>
CX023	205 0581 085	2P VH connector base	1
CX031	205 0343 090	8P connector base (KR-PH)	1
CY291	205 0549 027	28P PFC connector base	1
FL601	393 4095 007	FLO PIP10SM6	1
W301	204 8322 007	Headphone jack	1
W601	212 1101 008	Power switch TV-5	1
W801-806	212 5604 607	Tact switch -TA (ALPS)	6

### EXPLODED VIEW OF CHASSIS AND CABINET

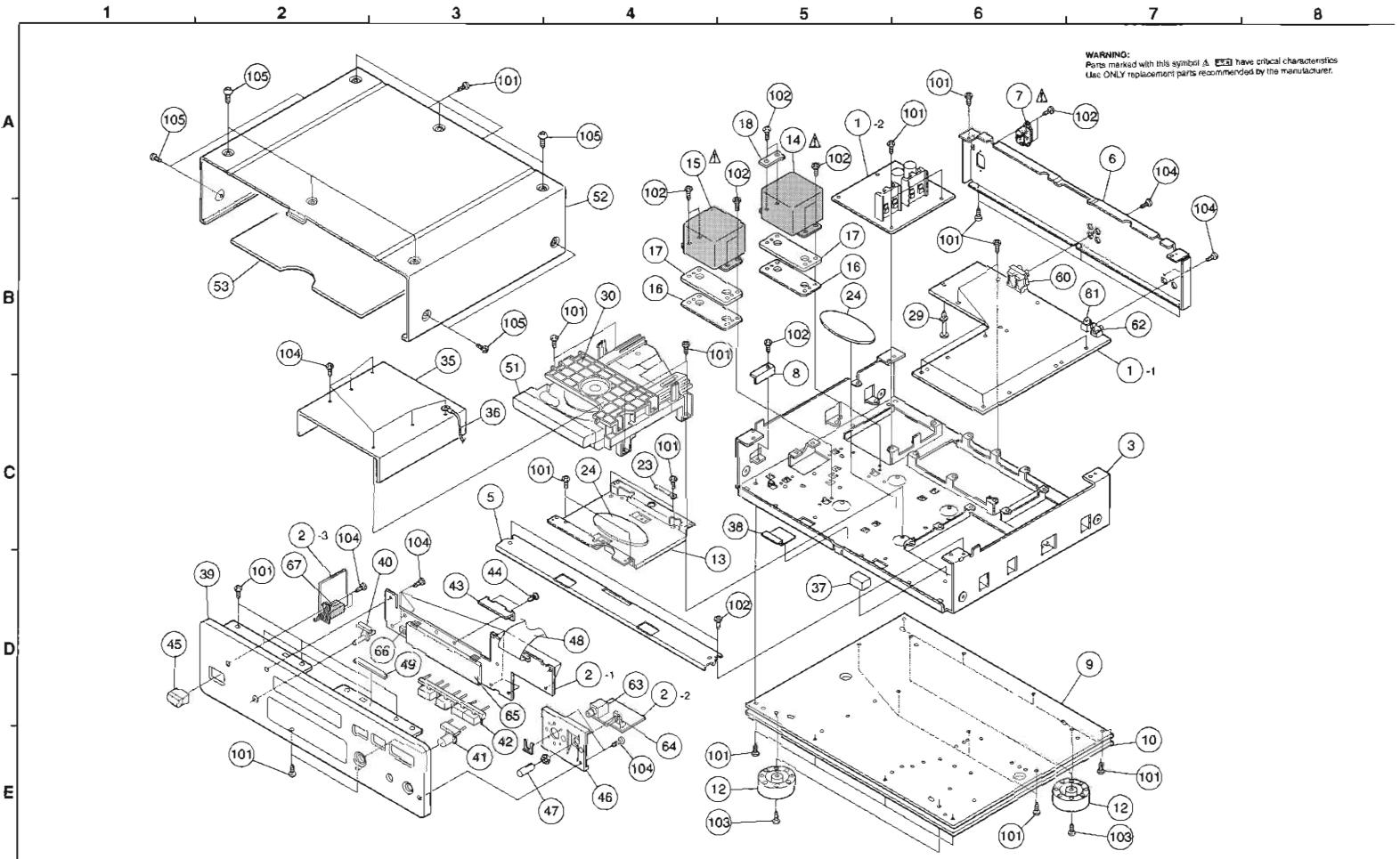

## PARTS LIST OF EXPLODED VIEW

Ref. No.	Part No.	Part Name	Remarks	Q'ty	Ref. No.	Part No.	Part Name	Remarks	Q'ty	
1	1U-3058	Main P.W.B. unit ass'y		1	48	009 0101 003	29P FFC cable	for DISP., CN291	1	
2	1U-3059	Display P.W.B unit ass'y		1	49	129 0140 151	Rubber sheet		2	
3	411 1317 206	Chassis		1	50	See Page 32	E2 laser caution		1	
4	513 2530 029	IC caution label		1	51	See Page 32	Loader panel ass'y		1	
5	411 1318 108	Front angle		1	52	See Page 32	Top cover		1	
6	105 1270 018	Rear panel		1	53	441 1709 103	Top cover damper		1	
△	7	See Page 32	AC inlet	1	54	See Page 32	Rating sheet		1	
8	See Page 32	Protector		1	55	See Page 32	FCC/class B caution		1	
9	105 1152 100	Inside bottom		1	56	See Page 32	Caution label (T)		1	
10	105 1151 305	Bottom cover		1	57	See Page 32	E3 label		1	
11	513 1220 000	Caution label		1	58	See Page 32	CUL label (1270)		1	
12	See Page 32	Foot ass'y		4	59	See Page 32	Manufac. date label		1	
13	412 2812 402	Mecha. fix bracket		1	60	204 8507 000	4P pinjack (AU)		1	
△	14	See Page 32	Power trans. (A.xx)	1	61	269 0098 006	GP1F32T (OPT. OUT)		1	
△	15	See Page 32	Power trans. (D.xx)	1	62	204 8417 006	1P pinjack (S-GND)		1	
16	129 0213 004	Trans. damper		2	63	204 8322 007	Headphone jack		1	
17	412 3957 007	Trans. plate		2	64	211 0764 001	Variable resistor 20 kohm	V0920FA203	1	
18	125 0078 001	Square washer		1	65	393 4095 007	FLD FIP10SM6		1	
19	513 1606 006	Power trans. label (A)		1	66	499 0290 007	Remote sensor GP1U27LX		1	
20	513 1607 005	Power trans. label (B)		1	△	67	212 1101 006	Power switch TV-5	1	
21	415 0767 037	UL tube (19) BK	L=70	1	<b>SCREWS</b>					
22	445 8004 007	Wire clamper		3	101	473 7002 021	Screw 3x8 CBTS(S)-B		47	
23	445 0048 016	Cord holder (L50)		3	102	473 7006 027	Screw 3x10 CBTS (S)-B		8	
24	129 0215 002	Bass rubber (S)		1	103	473 7007 013	Screw 4x10 CBTS(S)-B		4	
25	203 4547 032	3P EH connector cord (RD)	for AUDIO, CN031	1	104	473 7508 017	Screw 3x10 CBTS(P)-B		19	
26	203 4704 024	3P EH-EH connector cord	for AUDIO, CN032	1	105	See Page 32	3P. swelling screw		10	
27	204 2796 008	10P EH-EH connector cord	for SERBO, CN101	1	<b>PACKING &amp; ACCESSORIES (Not included EXPLODED VIEW)</b>					
△	28	203 5132 051	3P VH-VH connector cord	for POWER SW, CN023	1	201	505 0131 076	Cabinet cover		1
29	412 2937 002	Card spacer (L=20)		1	202	503 9275 102	Cushion		2	
30	337 0052 002	CD mecha. (TCD-78S)		1	203	See Page 32	Carton case		1	
33	203 8366 002	5P PH-PH connector cord	for CD MECH., L=100	1	204	505 0038 030	Poly. cover		1	
34	203 8299 030	5P KR-KR connector cord	for CD MECH., L=100	1	205	See Page 32	Instruction manual		1	
35	412 4256 011	Mecha. cover		1	206	See Page 32	Service station list (EX)		1	
36	203 0288 065	1P contact ass'y	M.COVER<-> MAIN, L=120	1	207	399 0290 008	Remote controller RC-255		1	
37	461 0889 015	Cushion (T:15)		1	208	204 8121 004	2P pin cord		1	
38	461 0992 009	Cover (PVC)		1	209	See Page 32	AC cord		1	
39	See Page 32	Front panel ass'y		1	210	513 1389 006	Control card base		1	
40	See Page 32	Input knob		1	211	513 1349 004	Thermal carbon film		1	
41	See Page 32	OP/CL knob		1	212	See Page 32	Label		1	
42	See Page 32	Function knob		1	213	See Page 32	Color label (gold)		2	
43	461 0989 009	Display cover		1	214	See Page 32	DEL warranty home		1	
44	477 0210 003	Push rivet		2						
45	See Page 32	P. knob (P) ass'y		1						
46	412 9468 105	H/P bracket		1						
47	See Page 32	Vol./knob (B)		1						

## ADDENDUM PARTS LIST PARTS LIST OF EXPLODED VIEW

Ref. No.	Part Name	Part No.	Part No.	Part No.	Part No.
		Europe Model	U.S.A & Canada Model DCD1650AR	Taiwan R.O.C (KOLIN) Model	Asia Model DCD2880AR
△ 7	AC Inlet	203 3970 008	203 3962 003	203 3962 003	203 3970 008
8	Protector	412 4244 007	—	—	412 4244 007
12	Foot ass'y	104 9044 013	104 0180 112	104 9044 013	104 9044 013
△ 14	Power trans. (A.E1)	233 6171 106	—	—	233 6171 106
△ 14	Power trans. (A.ET)	—	233 6237 008	233 6237 008	—
△ 15	Power trans. (D.E1)	233 6172 008	—	—	233 6172 008
△ 15	Power trans. (D.ET)	—	233 6238 104	233 6238 104	—
39	Front panel ass'y	144 2457 524	144 2457 540	144 2457 524	144 2457 537
40	Input knob	113 1705 037	113 1705 079	113 1705 037	113 1705 037
41	OP/CL knob	113 1705 040	113 1705 008	113 1705 040	113 1705 040
42	Function knob	113 1706 227	113 1706 007	113 1706 227	113 1706 227
45	P. knob (P) ass'y	113 9213 039	113 9213 000	113 9213 039	113 9213 039
47	Vol./knob (B)	112 0720 023	112 0720 049	112 0720 023	112 0720 023
50	E2 laser caution	513 2065 002	—	—	513 2065 002
51	Loader panel ass'y	144 2577 019	144 2577 022	144 2577 019	144 2577 019
52	Top cover	102 9048 259	102 0593 004	102 9048 259	102 9048 259
54	E2 rating sheet	513 2337 044	—	—	—
54	E3 rating sheet	—	513 2301 054	—	—
54	Kolin rating	—	—	513 2524 190	—
54	E1 rating sheet	—	—	—	513 2337 057
55	FCC/class B caution	—	513 2796 009	—	—
56	Caution label (T)	—	—	513 2482 009	—
57	E3 label	—	513 2697 001	—	—
58	CUL label (1270)	—	513 2377 004	—	—
59	Manufac. date label	—	513 1381 004	—	—
105	3P. swelling screw	477 0263 018	477 0263 005	477 0263 018	477 0263 018
203	Carton case	501 1999 008	501 1999 008	501 1999 008	501 1999 011
205	Instruction manual (B)	511 3232 003	511 3232 003	—	—
205	Instruction manual (E1)	—	—	511 3233 002	511 3233 002
206	Service station list (EX)	515 0671 601	515 0671 601	515 0671 601	515 0671 601
209	AC cord with connector	206 2154 002	—	206 2150 103	206 2154 002
209	AC cord set (E3)	—	206 2157 009	—	—
212	E2 POS label	517 1351 023	—	—	—
212	UPC label	—	517 0102 079	—	—
212	Kolin label (T)	—	—	513 2525 199	—
213	Color label (GOLD)	513 9111 001	—	513 9111 001	513 9111 001
214	DEL warranty home	—	515 0690 307	—	—



EXPLODED VIEW OF CD MECHANISM UNIT

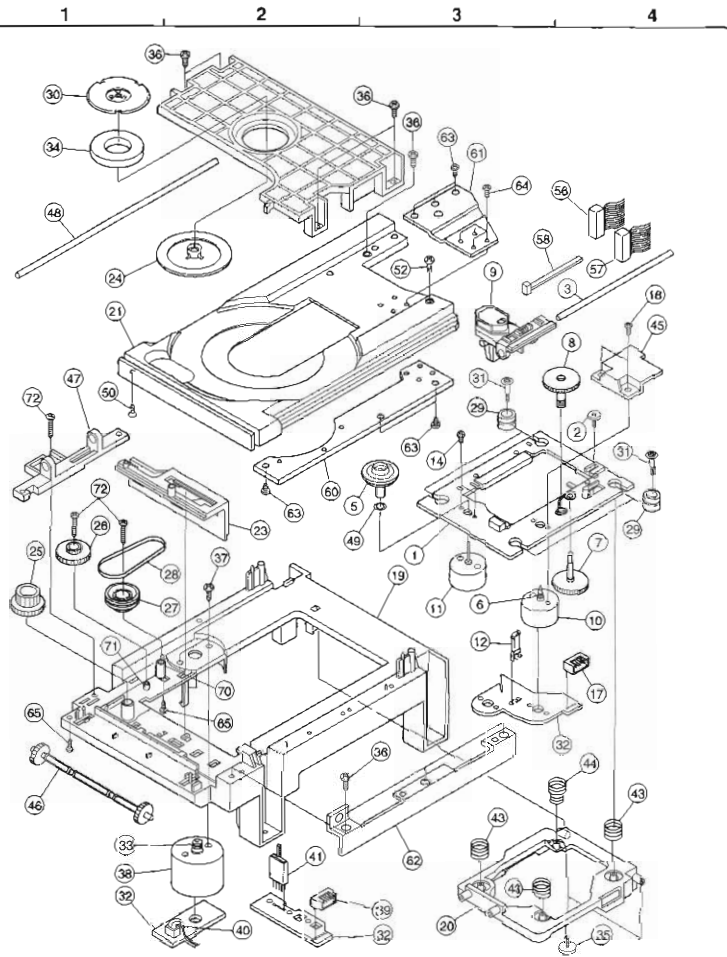

PARTS LIST OF MECHANISM UNIT ASS'Y  
TCD-78S CD MECHANISM UNIT ASS'Y

Ref. No.	Part No.	Part Name	Remarks	Q'ty	Ref. No.	Part No.	Part Name	Remarks	Q'ty
1		Base outer FG40	A25A001	1	55		Cushion 75	A4G017A	0.1
1-1		Base FG40	A85P009	1	56	204 0494 001	6P Shield wire	A4G019A	1
2		FS Filing screw	A90H006	1	57	204 0479 013	6P Connector cord	A4G020A	1
3		Fixed strap	A4H002A	1	58		Nylon band 7M	M01T122	2
5		Turn table Assy	A81A293	1	60	412 4242 009	Support bracket		1
6		Gear motor (FG40)	A85G028	1	61	412 4243 008	Loader bracket		1
7		Drive gear (A)	A85G017	1	62	425 0245 006	Bearing bracket Assy		1
8		Drive gear (B)	A85G018	1	63	473 7520 006	Screw 2.6x6 CPTS (F)-8		6
9	409 0269 005	Laser PU (HPC-1C)		1	64	471 2102 014	Screw 2x5 CFS		4
10		MT RF310T11400-30	M01T138	1	65	471 2203 010	Screw 2.6x5 CFS		2
11		MT RF310T11400-38	M01T131	1	70	443 1483 001	FG-Collar-10		1
12		Leaf switch (LSA-1121EAJ)	S01W147	1	71	443 0799 013	FG-Collar-8		1
13		Motor P.W.B. FG40N	A85P008	1	72	473 8806 009	Screw 3x25 CBTS (I)		3
14		Screw 2x2	M20S003	2					
17		ESB-PH Connector base	A82G253	1					
18		Screw 2x4	M20S004	2					
19	411 4319 505	Mechra chassis	A4G008C	1					
20		Mechra frame(FG70)	A85G020	1					
21	431 0380 345	Loader 77	A4G016C	1					
22	412 4246 006	Clamper holder	A4G009C	1					
23		UD Plate gear (FG70)	A4G005A	1					
24	421 0716 300	Clamper	A4G010C	1					
25		Relay gear(A)	A85G037	1					
26		Relay gear(B)	A85G008	1					
27		Relay gear(C)	A85G009	1					
28		Gear bell	A85G010	1					
29		Clamper (FG40)	A4G021A	4					
30		Clamper plate (FG40)	A85P007	1					
31		Screw (F)	A854001	4					
32		Motor P.W.B. FG70	A85P005	1					
33		Motor pulley A	A85G049	1					
34		Magnet 17 x 27 x 5	A82G057	1					
35		Special screw 3x10	A90H001	2					
36		Screw 3x5 Blind	B31B006	8					
37		Screw 2.6x4 Blind	M26B004	2					
38		MT RF500TB14415	M01T132	1					
39		ESB-PH (Red)	A82G308	1					
40		2P connector wire (FG70)	A85G027	1					
41		OP/CL Switch (SSS-12)	S01W148	1					
42		Spring(D)	A85S044	2					
43		Spring(B)	A85S042	1					
44		Spring(C)	A85S043	1					
45		Gear guide	A85G309	1					
46	424 0248 108	Loader gear	A4G013B	1					
47	431 0399 009	Holder		1					
48	431 0384 001	Slide shaft	A4H001A	1					
49		Washer	B22G029	1					
50		Screw 3x6 CFS	H30PK08	1					
51		Seal seal	LABKL01	1					
52		Screw 6x10 Blind	J30PK10	1					
53		Poly cover 300x400	A87G340	1					
54		Canon 75	A4P001A	0.1					

WIRING DIAGRAM

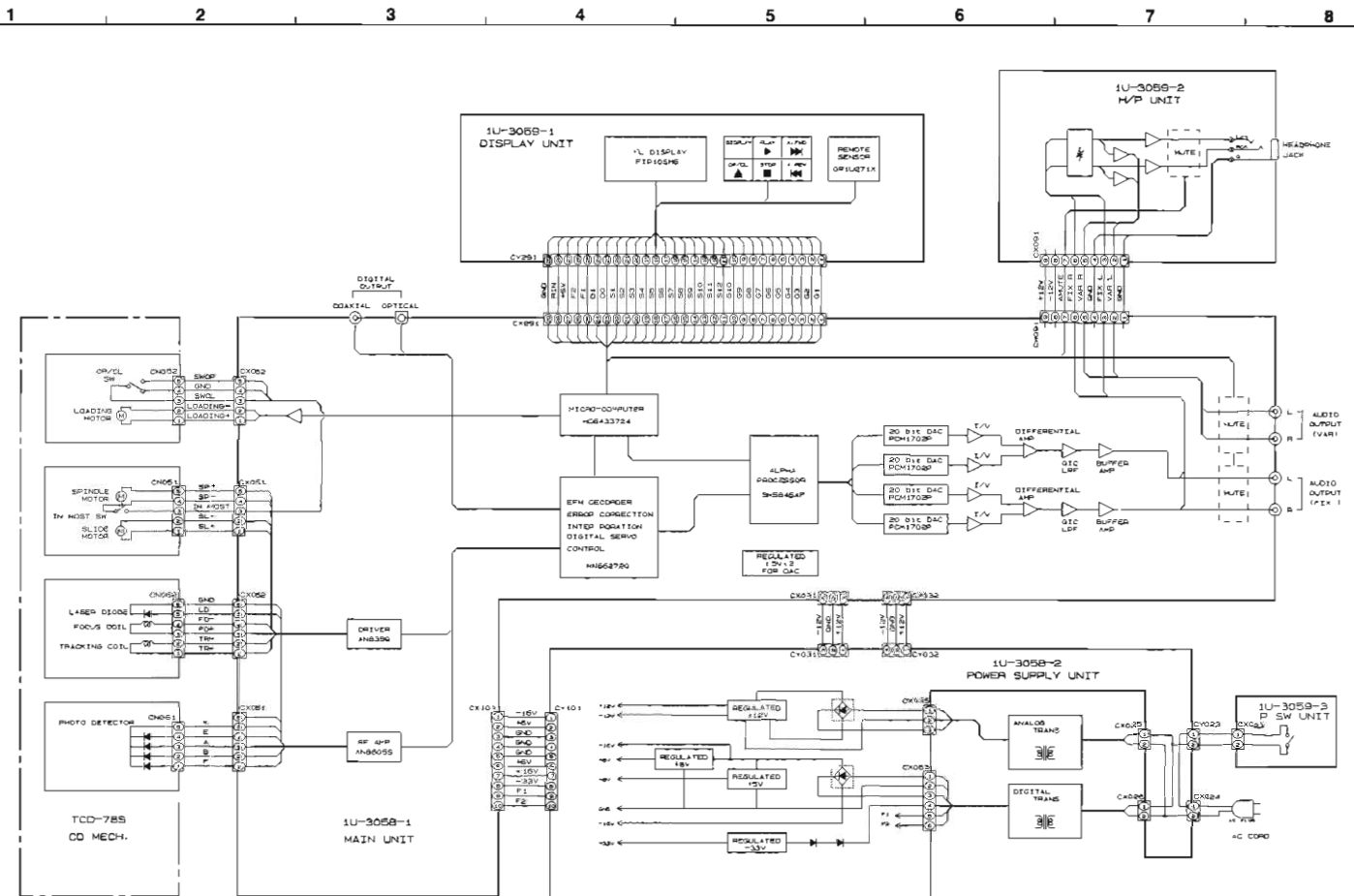



6

7

8

9

10

11

A

B

C

D

E

F

G

H

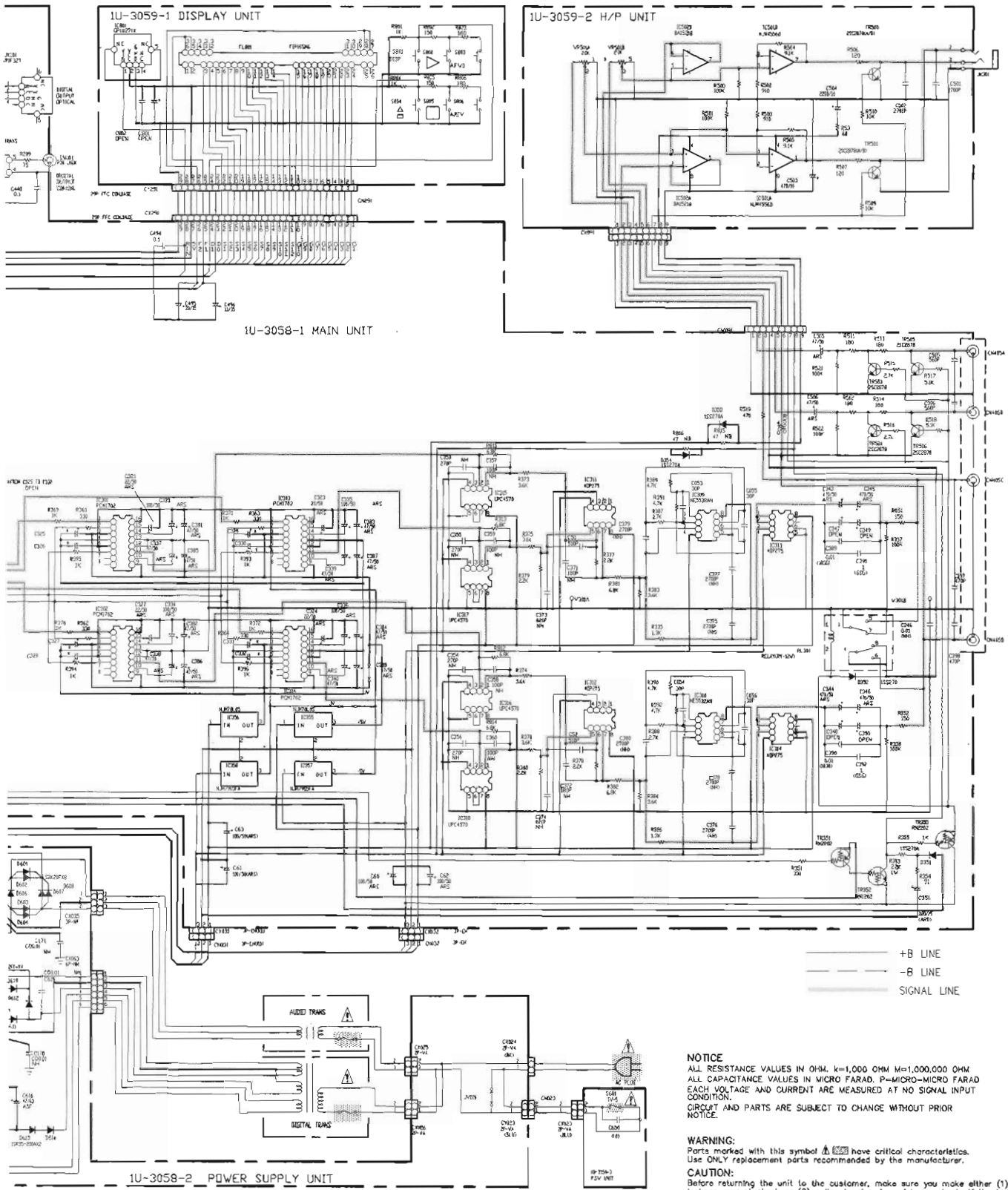

**NOTICE**  
 ALL RESISTANCE VALUES IN OHM, K=1,000 OHM M=1,000,000 OHM  
 ALL CAPACITANCE VALUES IN MICRO FARAD. P=MICRO-MICRO FARAD  
 EACH VOLTAGE AND CURRENT ARE MEASURED AT NO SIGNAL INPUT  
 CONDITION.  
 CIRCUIT AND PARTS ARE SUBJECT TO CHANGE WITHOUT PRIOR  
 NOTICE.

**WARNING:**  
 Parts marked with this symbol  have critical characteristics.  
 Use ONLY replacement parts recommended by the manufacturer.

**CAUTION:**  
 Before returning the unit to the customer, make sure you make either (1) a leakage current check or (2) a line to chassis resistance check. If the leakage current exceeds 0.5 millamps, or if the resistance from chassis to either side of the power cord is less than 240 kohms, the unit is defective.

**WARNING:**  
 DO NOT return the unit to the customer until the problem is located and corrected.